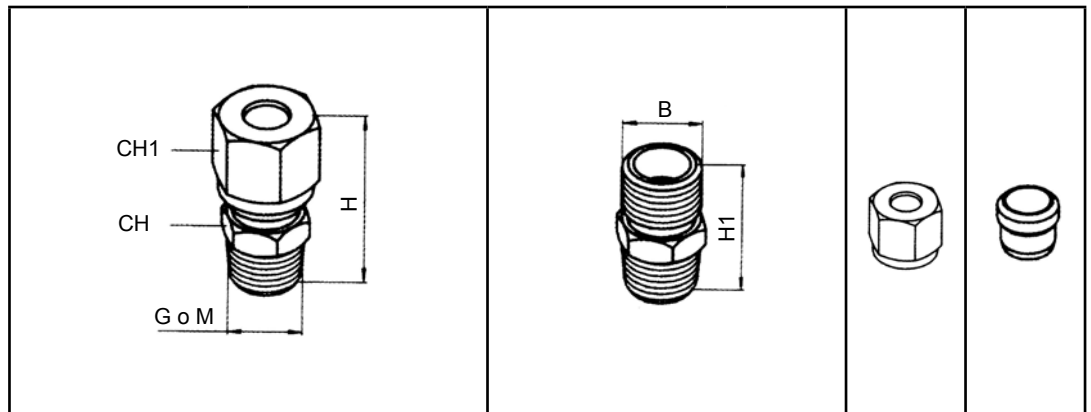

RACCORDERIA AD ANELLO
PRESSIONE MAX 40 MPa
RING FITTINGS
MAX PRESSURE 40 MPa (5800 PSI)

Tubo Tube	Filettatura Threads		Terminale completo Complete Fitting				Solo terminale Only Fitting			Dado Nut	Anello Ring	
	Ø	metric	BSP	Code	H	CH	CH1	Code	B	H1	Code	Code
6	-		1/8 ●	7104001	31	14	14	8104006	M12x1,5	25	8169017	8124001
6	-		1/4 ●	7104002	31	14	14	8104007	M12x1,5	25	8169017	8124001
6		M12x1 ▲		7104010	30,5	14	14	8104010	M12x1,5	24,5	8169017	8124001
6	-		1/4 ▲	7104011	30,5	14	14	8104011	M12x1,5	24,5	8169017	8124001
8	-		1/8 ●	7104003	31	14	17	8104008	M14x1,5	25	8169018	8124002
8	-		1/4 ●	7104004	31	14	17	8104009	M14x1,5	25	8169018	8124002
8	-		1/4 ▲	7104012	30,5	14	17	8104012	M14x1,5	24,5	8169018	8124002
8		M16x1 ▲		7104013	34,5	17	17	8104013	M14x1,5	26,5	8169018	8124002
10	-		1/4 ●	7104005	39	19	22	8104001	M18x1,5	30	8169020	8124003
10	-		3/8 ●	7104006	39	19	22	8104002	M18x1,5	30	8169020	8124003
10	-		3/8 ▲	7104014	38	19	22	8104014	M18x1,5	29	8169020	8124003
12	-		3/8 ●	7104007	40	22	24	8104003	M20x1,5	30	8169021	8124004
12	-		1/2 ●	7104008	47	22	24	8104004	M20x1,5	37	8169021	8124004
12	-		3/8 ▲	7104015	39	22	24	8104015	M20x1,5	29	8169021	8124004
16	-		3/8 ●	7104009	42	24	27	8104005	M24x1,5	32	8169022	8124005
16	-		3/8 ▲	7104016	41	24	27	8104016	M24x1,5	31	8169022	8124005
20	-		3/4 ▲	7104017	58	32	36	8104017	M30x2	47	8169023	8124006
30	-		1 1/4 ▲	7104018	70	50	50	8104018	M42x2	57	8169024	8124007
8	-		1/4 ■	7104020	42	19	19	8104020	M16x1,5	34	8169019	8124002
10	-		1/4 ■	7104021	43	19	22	8104021	M18x1,5	34,5	8169020	8124003
10	-		3/8 ■	7104022	43	22	22	8104022	M18x1,5	34,5	8169020	8124003
12	-		1/4 ■	7104023	45	22	24	8104023	M20x1,5	36,5	8169021	8124004
12	-		3/8 ■	7104024	45	22	24	8104024	M20x1,5	36,5	8169021	8124004
16	-		3/8 ■	7104025	49	27	27	8104025	M24x1,5	41	8169022	8124005

- Filettatura cilindrica con tenuta senza guarnizione
- ▲ Filettatura cilindrica
- Filettatura conica

- Cylindrical thread with seal without gasket
- ▲ Cylindrical thread
- Taper thread

RACCORDERIA AD ANELLO
PRESSIONE MAX 40 MPa

RING FITTINGS
MAX PRESSURE 40 MPa (5800 PSI)

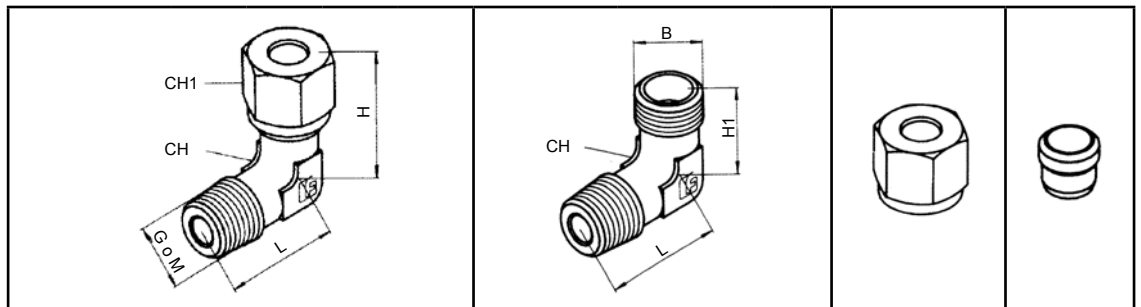

Tubo Tube Ø	Filettatura Thread BSP	Terminale completo Complete Fitting					Solo terminale Only fitting			Dado Nut	Anello Ring
		Code	H	L	CH	CH1	Code	B	H1	Code	Code
6	1/4	7105001	31	23	12	14	8105001	M12x1,5	23	8169017	8124001
8	1/4	7105002	31,5	24	14	17	8105002	M14x1,5	24	8169018	8124002
10	1/4	7105003	34,5	25	17	22	8105003	M18x1,5	25	8169020	8124003
10	3/8	7105004	34,5	25	17	22	8105004	M18x1,5	25	8169020	8124003
12	3/8	7105005	39	29	17	24	8105005	M20x1,5	29	8169021	8124004
16	3/8	7105006	43	33	24	27	8105006	M24x1,5	33	8169022	8124005
20	3/4 ▲	7105007	48	42	27	36	8105007	M30x2	37	8169023	8124006
30	1 1/4 ▲	7105008	62	54	41	50	8105008	M42x2	49	8169024	8124007

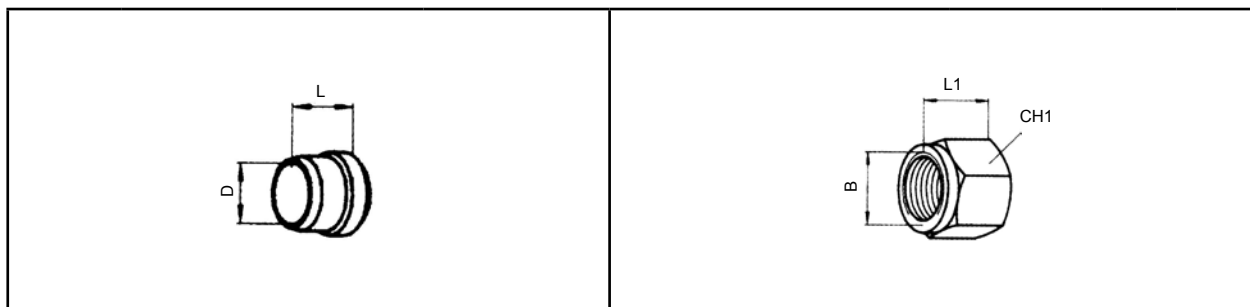

Tubo Tube Ø D	Anello Ring	Quote Dimensions	Dado Nut	Filettatura Thread	Quote Dimensions	
	Code	L	Code	B	L1	CH1
6	8124001	9,5	8169017	M12x1,5	13	14
8	8124002	9,5	8169018	M14x1,5	15	17
8	8124002	9,5	8169019	M14x1,5	16,5	19
10	8124003	10	8169020	M18x1,5	15	22
12	8124004	10	8169021	M20x1,5	17	24
16	8124005	10,5	8169022	M24x1,5	18	27
20	8124006	12,5	8169023	M30x2	24	36
30	8124007	13	8169024	M42x2	29	50

▲ Filettatura cilindrica
▲ Cylindrical thread

RACCORDERIA AD ANELLO
PRESSIONE MAX 40 MPa

GIUNZIONI DIRITTE / STRAIGHT JOINTS

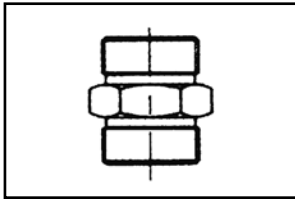

Codice Code	Ø Tubo Tube	Filettatura Thread
8102001	6	M12x1,5
8102002	8	M14x1,5
8102003	10	M18x1,5
8102004	12	M20x1,5
8102005	16	M24x1,5
8102006	20	M30x2
8102007	30	M42x2

RING FITTINGS
MAX PRESSURE 40 MPa (5800 PSI)

GIUNZIONI DIRITTE COMPLETE / COMPLETE STRAIGHT JOINTS

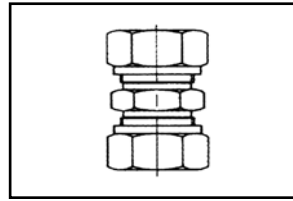

Codice Code	Ø Tubo Tube
7102001	6
7102002	8
7102003	10
7102004	12
7102005	16
7102006	20
7102007	30

GIUNZIONI A 90° / 90° JOINTS

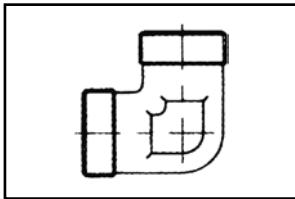

Codice Code	Ø Tubo Tube	Filettatura Thread
8102008	6	M12x1,5
8102009	8	M14x1,5
8102010	10	M18x1,5
8102011	12	M20x1,5
8102012	16	M24x1,5
8102013	20	M30x2
8102014	30	M42x2

GIUNZIONI A 90° COMPLETE / COMPLETE 90° JOINTS

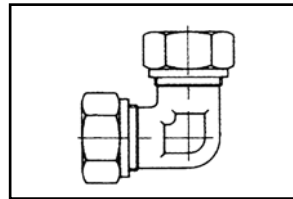

Codice Code	Ø Tubo Tube
7102008	6
7102009	8
7102010	10
7102011	12
7102012	16
7102013	20
7102014	30

GIUNZIONI A "T" / "T" JOINTS

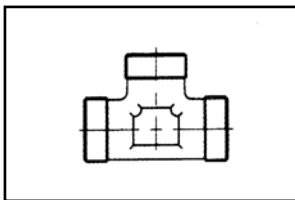

Codice Code	Ø Tubo Tube	Filettatura Thread
8102015	6	M12x1,5
8102016	8	M14x1,5
8102017	10	M18x1,5
8102018	12	M20x1,5
8102019	16	M24x1,5
8102020	20	M30x2
8102021	30	M42x2

GIUNZIONI A "T" COMPLETE / COMPLETE "T" JOINTS

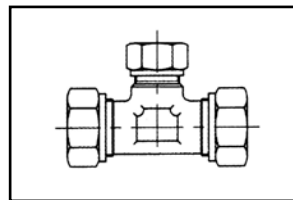

Codice Code	Ø Tubo Tube
7102015	6
7102016	8
7102017	10
7102018	12
7102019	16
7102020	20
7102021	30

GIUNZIONI A CROCE / CROSS JOINTS

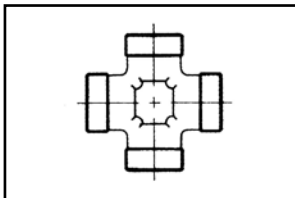

Codice Code	Ø Tubo Tube	Filettatura Thread
8102036	6	M12x1,5
8102037	8	M14x1,5
8102038	10	M18x1,5
8102039	12	M20x1,5
8102040	16	M24x1,5
8102041	20	M30x2
8102042	30	M42x2

GIUNZIONI A CROCE COMPLETE / COMPLETE CROSS JOINTS

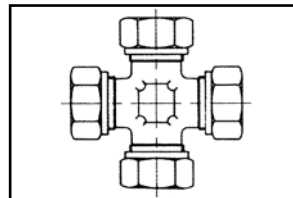

Codice Code	Ø Tube Tube
7102026	6
7102027	8
7102028	10
7102029	12
7102030	16
7102031	20
7102032	30

GIUNZIONI DIRITTE DI RIDUZIONE
REDUCING STRAIGHT JOINTS

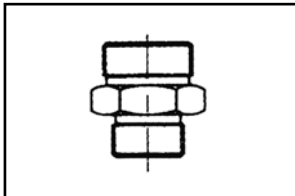

Codice Code	Ø Tubo Tube	Filettatura Thread
8102033	8 / 6	M14x1,5 / M12x1,5
8102034	10 / 8	M18x1,5 / M14x1,5
8102035	12 / 10	M20x1,5 / M18x1,5

GIUNZIONI DIRITTE DI RIDUZIONE COMPLETE
COMPLETE REDUCING STRAIGHT JOINTS

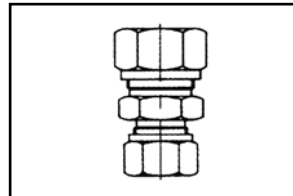

Codice Code	Ø Tubo Tube
7102033	8 / 6
7102034	10 / 8
7102035	12 / 10

GIUNZIONI a 90° DI RIDUZIONE
REDUCING STRAIGHT JOINTS

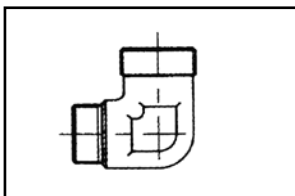

Codice Code	Ø Tubo Tube	Filettatura Thread
8102026	10 / 8	M18x1,5 / M14x1,5
8102027	16 / 8	M24x1,5 / M14x1,5
8102028	16 / 10	M24x1,5 / M18x1,5

GIUNZIONI a 90° DI RIDUZIONE COMPLETE
COMPLETE REDUCING STRAIGHT JOINTS

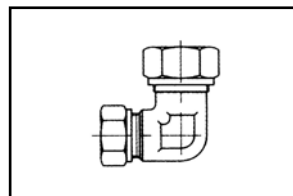

Codice Code	Ø Tubo Tube
7102036	10 / 8
7102037	16 / 8
7102038	16 / 10

RACCORDERIA AD ANELLO PRESSIONE MAX 40 MPa

GIUNZIONI A "T" DI RIDUZIONE / REDUCTION "T" JOINTS

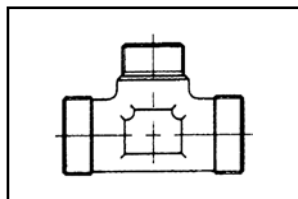

Codice Code	Filettatura Thread
8102022	M14x1,5/M12x1,5/M14x1,5
8102023	M18x1,5/M14x1,5/M18x1,5
8102024	M24x1,5/M14x1,5/M24x1,5
8102025	M24x1,5/M18x1,5/M24x1,5

RING FITTINGS MAX PRESSURE 40 MPa (5800 PSI)

GIUNZIONI A "T" DI RIDUZIONE COMPLETE COMPLETE REDUCTION "T" JOINTS

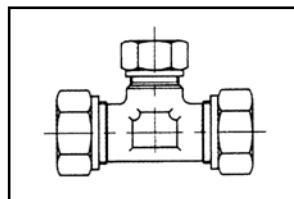

Codice Code	Ø Tubo Tube
7102022	8 / 6 / 8
7102023	10 / 8 / 10
7102024	16 / 8 / 16
7102025	16 / 10 / 16

GUARNIZIONI / GASKETS

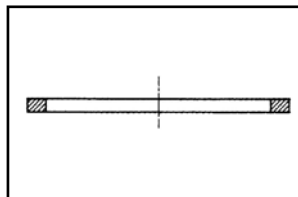

Codice Code	Filettatura Thread
8161051	Per termin. M12x1-alluminio/ For terminal M12x1 aluminium
8161052	Per termin. 1/4 BSP-acciaio/ For terminal 1/4 BSP steel
8161040	Per termin. 3/8 BSP-alluminio/ For terminal 1/4 BSP aluminium
8161053	Per termin. M16x1-acciaio/ For terminal M16x1 BSP steel
8161055	Per termin. 3/4 BSP-rame/ For terminal 3/4 BSP copper
8161056	Per termin. 1 1/4 BSP-rame/ For terminal 1 1/4 BSP copper
8161050	Per termin. M10x1-rame/ For terminal M10x1 copper

RACCORDI ATTRAVERSAMENTO PARETE WALL CROSSING FITTING

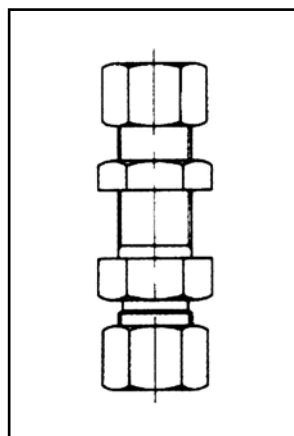

Codice Code	Ø Tubo Tube
8249114	6
8249115	8
8249116	10
8249117	12
8249118	16
8249119	20
8249120	30

RIDUZIONI / REDUCTIONS

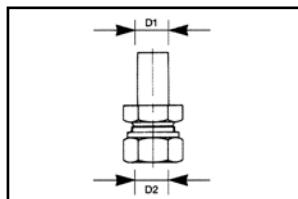

Codice Code	Ø Tubo / Tube	
	D1	D2
9256001	12	10
9256002	16	12
9256003	20	10
9256004	20	12
9256005	20	16
9256006	30	20
9256007	30	16
9256008	30	10
9256009	30	12

TAPPI / PLUGS

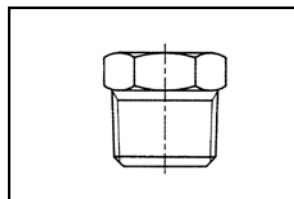

Codice Code	Filettatura Thread
8289007	M8x1 DIN158
8289038	1/8 BSP ●
8289039	1/4 BSP ●
8289040	3/8 BSP ●
8289013	M12x1 ▲
8289012	1/4 BSP ▲
8289041	3/8 BSP ▲
8289042	M16x1,5 ▲
8289043	1/4 BSP

TAPPI / PLUGS

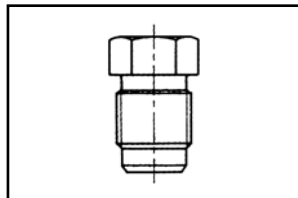

Codice Code	Filettatura Thread
8289044	5/16-24NF
8289045	1/8 BSP ▲
8289005	M10x1 ▲
8289046	1/4 BSP ▲
8289047	M14x1,5 ▲
8289048	3/8 BSP ▲

TAPPI / PLUGS

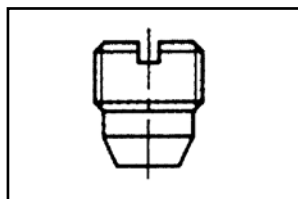

Codice Code	Filettatura Thread
8289051	5/16-24NF
8289052	1/8 BSP ▲
8289053	M10x1 ▲
8289054	1/4 BSP ▲

GRANI / GRUB SCREW

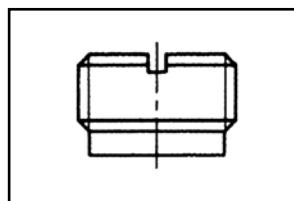

Codice Code	Filettatura Thread
8186015	M10x1 ▲
8186016	M12x1 ▲
8286017	M16x1 ▲
8186018	1/4 BSP ▲

▲ Filettatura cilindrica
● Filettatura conica

▲ Cylindrical thread
● Taper thread