

## **WASH-UP BLADES LAME LAVARULLI**

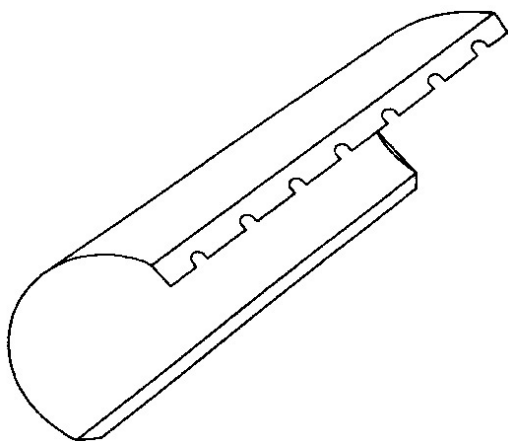
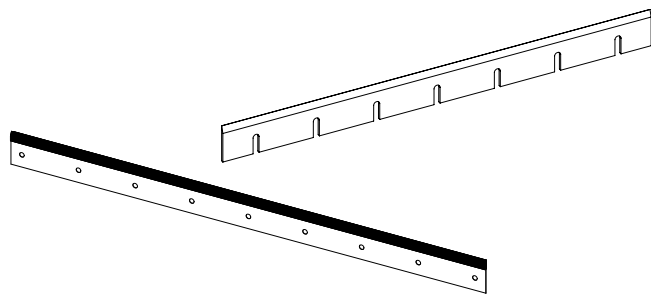

## **OFFSET PRINTING CYLINDER JACKETS CAMICIE DEL CILINDRO STAMPA**

## **PUNCHING PLATES**

### **PIASTRE PER FUSTELLARE**

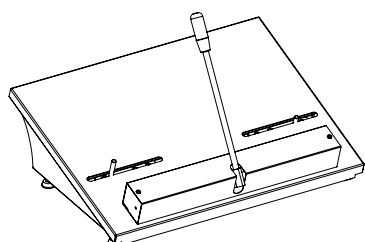
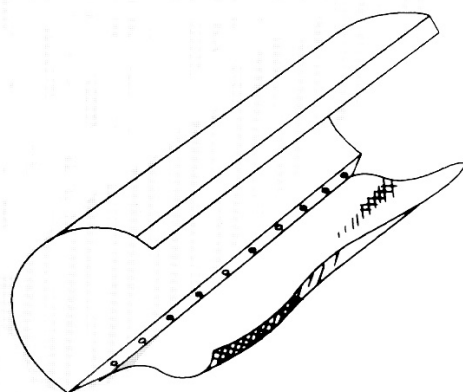

## **REGISTER SYSTEMS SISTEMI DI REGISTRO**

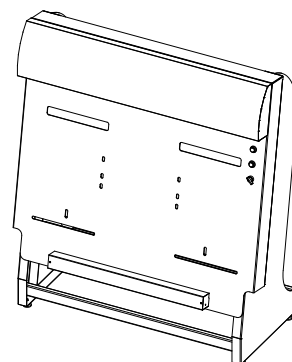

**CONTENTS****INDICE**

WASH-UP BLADES	3	LAME LAVARULLI
CYLINDER JACKETS	20	CAMICIE CILINDRO STAMPA
ANTI MARKING SYSTEMS	23	RIVESTIMENTI "ANTI-MARKING"
PUNCHING PLATES	24	PIASTRE PER FUSTELLARE
INK DUCT END BLOCKS	26	SPALLE DEL CALAMAIO
INK FOUNTAIN BLADES	28	LAME DEL CALAMAIO
INK DUCT FOILS	29	COPRICALAMAI
MITSUBISHI CYLINDER WASHING BARS	29	BARRE LAVACILINDRO MITSUBISHI
PARTS FOR HEIDELBERG GTO	30	RICAMBI PER HEIDELBERG GTO
PARTS FOR TYPOGRAPHIC	33	RICAMBI PER MACCHINE TIPOGRAFICHE
PARTS FOR HEIDELBERG PLATEN	34	RICAMBI PER STELLA HEIDELBERG
PARTS FOR FEEDER	36	RICAMBI PER METTIFOGLIO
PARTS FOR HOT STAMPING	37	PARTI PER STAMPA A CALDO
PARTS FOR CUTTING/CREASING	38	RICAMBI PER TAGLIO/CORDONATURA
BOBST SPARE PARTS	39	PARTI DI RICAMBIO PER BOBST
SHEET SEPARATORS	40	LINGUETTE SEPARAFOGLI
OTHER SPARE PARTS	44	ALTRE PARTI DI RICAMBIO
QUOINS	46	SERRAFORME
HICKEY REMOVERS	47	RACCOGLI GRUMI
FLAT SUCKERS	48	VENTOSE PIATTE
SHAPED SUCKERS	49	VENTOSE SAGOMATE
PIN BARS AND REGISTER PUNCHES	50	BARRETTE DI REGISTRO E PUNZONATRICI
JOGGING BLOCKS	52	SPINGI BLOCCHI
CUTTING STICKS	53	LISTELLI SOTTOLAMA
CREASING MATRIX	56	CANALETTO CORDONATORE
STEEL STAPLES	58	PUNTI METALLICI
STITCHING WIRE	58	FILO METALLICO
CREASING RULES	59	FILETTI PER FUSTELLE
OFFSET RULES	59	NASTRI PERFORATORI OFFSET
PAPER DRILL BITS	60	PUNTE PER TRAPANO
TRANSMISSION BELTS	62	CINGHIE DI TRASMISSIONE
FEEDER BELTS	63	CINGHIE PER METTIFOGLIO
SMALL PUNCHES	64	FUSTELLINE
METALLIC EYELETS	64	OCCHIELLI METALLICI
TERMOGRAPHIC POWDER	64	POLVERE PER RILIEVO
GLUE	64	COLLA
PRE-PRESS	65	PRESTAMPA
MAGNIFIERS	65	LENTINI
MEASURING INSTRUMENTS	65	STRUMENTI DI MISURA
WASHING	66	LAVAGGIO
BI-ADHESIVE	66	BIADESIVO
PACKAGING	66	IMBALLO
INK KNIVES	67	SPATOLE PER INCHIOSTRO
PLASTIC FEEDER WEDGES	67	CUNEI IN PLASTICA
OTHERS	67	ARTICOLI VARI
CONDITIONS OF SALES	66	CONDIZIONI DI VENDITA

## AB - DICK

Ref. Codice	Model Descrizione	Machine Size Dim. macchina	Lenght Lunghezza	Width Altezza	Thick. Spess.	Material / Materiale						€
						S+R	F+G	Gomma Rubber	Teflon	Plastic Plastica	Other Altro	
<b>5803</b>	AB - DICK 9995	-	360	50	5			●				
<b>5804</b>	AB - DICK	-	349	45	5			●				

## ADAST (ROMAYOR)

Ref. Codice	Model Descrizione	Machine Size Dim. macchina	Lenght Lunghezza	Width Altezza	Thick. Spess.	Material / Materiale						€
						S+R	F+G	Gomma Rubber	Teflon	Plastic Plastica	Other Altro	
<b>5405</b>	GRAFOPRESS GPA/GPC/GPE	26 x 38	383	21	5			●				
<b>5419</b>	ADAST 500	-	547	38	0,5	●						
<b>5410</b>	DOMINANT 414	26 x 38	302	25	3			●				
<b>5415</b>	DOMINANT 313/314	35 x 50	540	28	3			●				
<b>5420</b>	DOMINANT 513	35 x 50	570	32	3			●				
<b>5425</b>	DOMINANT 514/515/524/525/526-B	35 x 50	536	24	3			●				
<b>5426</b>	DOMINANT 516/526/547-P	35 x 50	557	25	3			●				
<b>5427</b>	DOMINANT 516/526 numbering - numerazione	35 x 50	562	21	3			●				
<b>5430</b>	DOMINANT 712	35 x 50	630	36	3			●				
<b>5435</b>	DOMINANT 714/724/715/725/745/755-P	48 x 66	665	28	3			●				
<b>5407</b>	DOMINANT 807	-	781	38	0,5	●						
<b>5436</b>	DOMINANT 826	-	800	34	3			●				

## AKIRA

Ref. Codice	Model Descrizione	Machine Size Dim. macchina	Lenght Lunghezza	Width Altezza	Thick. Spess.	Material / Materiale						€
						S+R	F+G	Gomma Rubber	Teflon	Plastic Plastica	Other Altro	
<b>5972</b>	AKIRA 18 EF	-	526	58	0,5	●						
<b>5973</b>	AKIRA	-	532	53	0,5	●						

## AKIYAMA

Ref. Codice	Model Descrizione	Machine Size Dim. macchina	Lenght Lunghezza	Width Altezza	Thick. Spess.	Material / Materiale						€
						S+R	F+G	Gomma Rubber	Teflon	Plastic Plastica	Other Altro	
<b>5724</b>	AKIYAMA 26	50 x 70	790	45	5			●				
<b>5725</b>	AKIYAMA 28	51 x 72	810	45	5			●				
<b>5718</b>	AKIYAMA BESTECH 28 SPECIAL	51 x 72	805	45	5			●				
<b>5726</b>	AKIYAMA 40	72 x 102	1.124	50	5			●				

# AURELIA (HARRIS - OMCSA)

Ref. Codice	Model Descrizione	Machine Size Dim. macchina	Lenght Lunghezza	Width Altezza	Thick. Spess.	Material / Materiale						€
						S+R F+G	Gomma Rubber	Teflon	Plastic Plastica	Other Altro		
<b>5505</b>	AURELIA 46/48/52/248/252	-	800	24	2			●				
<b>5506</b>	AURELIA 63	-	970	30	2			●				
<b>5510</b>	AURELIA 61/72	-	1.060	24	2			●				
<b>5515</b>	AURELIA 76/82/92	-	1.380	24	2			●				
<b>5573</b>	HARRIS 110	-	750	68	0,5	●						
<b>5520</b>	OMCSA A 125 up to year - fino al 1985	50 x 70	705	65	0,5	●						
<b>5521</b>	OMCSA A 125 over year - dopo il 1985	50 x 70	690	65	0,5	●						
<b>5521</b>	OMCSA A 125 numbering unit - gruppo numerazione	50 x 70	690	65	0,5	●						
<b>5525</b>	OMCSA A 136 HARRIS AURELIA	64 x 95	974	65	0,5	●						
<b>5560</b>	HARRIS 200	-	1.065	60	0,5	●						
<b>5565</b>	HARRIS 200	-	1.065	78	0,5	●						
<b>5530</b>	OMCSA A 500-520 HARRIS AURELIA	51 x 73	820	65	0,5	●						
<b>5574</b>	HARRIS M 600 ROTOOFFSET - WEB 16	-	1.036	53	2	●						
<b>5535</b>	AURELIA 700 ELITE holes dist. - intrasse fori 100mm	70 x 100	1.070	65	0,5	●						
<b>5534</b>	AURELIA 700 holes distance - interasse fori 95mm	70 x 100	1.070	65	0,5	●						
<b>5555</b>	OMCSA HARRIS 700	70 x 100	1.070	65	0,5	●						
<b>5572</b>	HARRIS M 850 A-B upper - superiore	-	1.065	38	0,5	●						
<b>5565</b>	HARRIS M 850 A-B lower - inferiore	-	1.065	78	0,5	●						
<b>5570</b>	HARRIS M 850 L upper - superiore	-	1.540	65	0,5	●						
<b>5571</b>	HARRIS M 850 L lower - inferiore	-	1.540	88	0,5	●						
<b>5545</b>	HARRIS 24 ROTOOFFSET 990	-	1.043	65	0,5	●						
<b>5566</b>	HARRIS 1.000 M200-M300	-	1.043	65	0,5	●						
<b>5567</b>	HARRIS 1.000	-	1.043	103	0,5	●						
<b>5564</b>	HARRIS M 1.000	-	1.062	103	0,5	●						

## CANVIT

Ref. Codice	Model Descrizione	Machine Size Dim. macchina	Lenght Lunghezza	Width Altezza	Thick. Spess.	Material / Materiale						€
						S+R F+G	Gomma Rubber	Teflon	Plastic Plastica	Other Altro		
<b>5937</b>	CANVIT FLEXI ROLLS	-	514	35	3			●				
<b>5938</b>	CANVIT FLEXI ROLLS	-	530	42	3			●				

## CODIMAG

Ref. Codice	Model Descrizione	Machine Size Dim. macchina	Lenght Lunghezza	Width Altezza	Thick. Spess.	Material / Materiale						€
						S+R F+G	Gomma Rubber	Teflon	Plastic Plastica	Other Altro		
<b>5935</b>	CODIMAX MIXTE - HAMADA 80	-	540	40	5		●					
<b>5936</b>	CODIMAG M13 - M16 - M21	-	535	37	5		●					

## CRABTREE

Ref. Codice	Model Descrizione	Machine Size Dim. macchina	Lenght Lunghezza	Width Altezza	Thick. Spess.	Material / Materiale							€
						S+R F+G	Gomma Rubber	Teflon	Plastic Plastica	Other	Altro		
<b>5689</b>	CRABTREE 40 tin lithographic press	-	1.100	152	7						●		
<b>5691</b>	CRABTREE 45 tin lithographic press	-	1.220	152	7						●		
<b>5695</b>	CRABTREE 1.200 tin lithographic press - 130	-	1.345	43	0,5	●							
<b>5692</b>	CRABTREE	-	1.100	150	6						●		
<b>5693</b>	CRABTREE 45"	-	1.257	38	0,5	●							

## DAVIDSON

Ref. Codice	Model Descrizione	Machine Size Dim. macchina	Lenght Lunghezza	Width Altezza	Thick. Spess.	Material / Materiale							€
						S+R F+G	Gomma Rubber	Teflon	Plastic Plastica	Other	Altro		
<b>5760</b>	DAVIDSON 500/501/502p	25 x 35	298	60	0,5	●							
<b>5765</b>	DAVIDSON 700/701/702p	45 x 38	470	60	0,5	●							
<b>5770</b>	DAVIDSON 900/901/902p	35 x 50	530	60	0,5	●							

## DIDDE

Ref. Codice	Model Descrizione	Machine Size Dim. macchina	Lenght Lunghezza	Width Altezza	Thick. Spess.	Material / Materiale							€
						S+R F+G	Gomma Rubber	Teflon	Plastic Plastica	Other	Altro		
<b>5947</b>	DIDDE GLASER APOLLO 8 <sup>1</sup> / <sub>4</sub> " - 8 <sup>1</sup> / <sub>2</sub> "	-	405	35	3						●		
<b>5949</b>	DIDDE GLASER 860	-	495	35	1						●		
<b>5952</b>	DIDDE GLASER VIP	-	571	35	1						●		
<b>5950</b>	DIDDE CONSERVER PRESS	-	396	58	0,5	●							

## DRENT

Ref. Codice	Model Descrizione	Machine Size Dim. macchina	Lenght Lunghezza	Width Altezza	Thick. Spess.	Material / Materiale							€
						S+R F+G	Gomma Rubber	Teflon	Plastic Plastica	Other	Altro		
<b>5953</b>	DRENT GAZELLE 8	-	480	45	2			●					
<b>5954</b>	DRENT GAZELLE 2 B	-	575	31	5		●						
<b>5955</b>	DRENT GAZELLE 3 C	-	555	30	5		●						
<b>5957</b>	DRENT GAZELLE 4 D	-	585	23	2			●					
<b>5956</b>	DRENT GAZELLE 4 F	-	600	45	2			●					
<b>5958</b>	DRENT GAZELLE 5 E	-	575	50	2			●					
<b>5956</b>	DRENT GAZELLE 4 G	-	600	30	2			●					
<b>5961</b>	DRENT GAZELLE L	-	564	35	2			●					
<b>5990</b>	DRENT GAZELLE VISION	-	575	33	3			●					
<b>5740</b>	DRENT GAZELLE VISION	-	570	30	0,5	●							

## DRENT

Ref. Codice	Model Descrizione	Machine Size Dim. macchina	Lenght Lunghezza	Width Altezza	Thick. Spess.	Material / Materiale						€
						S+R F+G	Gomma Rubber	Teflon	Plastic Plastica	Other	Altro	
<b>5984</b>	DRENT GAZELLE 6	-	545	41	2				●			
<b>5959</b>	DRENT GAZELLE 6 K	-	508	35	3				●			
<b>5985</b>	DRENT GAZELLE 6 L	-	520	40	3				●			
<b>5960</b>	DRENT GAZELLE 6 P	-	540	40	3				●			
<b>5989</b>	DRENT GAZELLE 6 T	-	535	35	2				●			
<b>5904</b>	DRENT GAZELLE 6 IMR	- 6	560	36	3				●			

## EDELMAN FORM-ALL

Ref. Codice	Model Descrizione	Machine Size Dim. macchina	Lenght Lunghezza	Width Altezza	Thick. Spess.	Material / Materiale						€
						S+R F+G	Gomma Rubber	Teflon	Plastic Plastica	Other	Altro	
<b>5924</b>	VARIO PRINT	-	576	60	0,5	●						
<b>5924</b>	WEB PRINT 52	-	576	60	0,5	●						
<b>5911</b>	FORM PRINT	-	490	65	0,5	●						
<b>5923</b>	PACK PRINT ROLL P.P.	-	415	58	0,5	●						
<b>5923</b>	COMPUTER PRINT V38 - C38	-	415	58	0,5	●						
<b>5375</b>	MINI PRINT	-	550	58	0,5	●						
<b>5912</b>	EDELMAN WEB 39	-	410	60	0,5	●						
<b>5901</b>	EDELMAN WEB 48,5	-	520	60	0,5	●						
<b>5914</b>	EDELMAN WEB V 72	-	774	58	0,5	●						

## FAG

Ref. Codice	Model Descrizione	Machine Size Dim. macchina	Lenght Lunghezza	Width Altezza	Thick. Spess.	Material / Materiale						€
						S+R F+G	Gomma Rubber	Teflon	Plastic Plastica	Other	Altro	
<b>5996</b>	WIFAG 07 ROTOOFFSET	-	820	33	0,5	●						
<b>5997</b>	FAG OP 104 - 104 ALFA - 104 BETA	-	1.090	58	0,5	●						
<b>5998</b>	FAG 4 COLORS	70 x 100	1.158	48	0,5	●						
<b>6025</b>	WIFAG 160	-	1.610	48	0,5	●						

## FORM CONSULTA

Ref. Codice	Model Descrizione	Machine Size Dim. macchina	Lenght Lunghezza	Width Altezza	Thick. Spess.	Material / Materiale						€
						S+R F+G	Gomma Rubber	Teflon	Plastic Plastica	Other	Altro	
<b>5925</b>	FORM CONSULTA FC 50	-	550	26	0,5	●						
<b>5926</b>	FORM CONSULTA FC 50 old model	-	570	26	0,5	●						
<b>5927</b>	FORM CONSULTA FC 50 numbering - numeraz.	-	590	26	0,5	●						

## FUJI - SHINOHARA

Ref. Codice	Model Descrizione	Machine Size Dim. macchina	Lenght Lunghezza	Width Altezza	Thick. Spess.	Material / Materiale						€
						S+R F+G	Gomma Rubber	Teflon	Plastic Plastica	Other Altro		
<b>5605</b>	FUJI 50	35 x 50	550	48	2	●						
<b>5610</b>	FUJI 52	36 x 52	580	43	2	●						
<b>5612</b>	FUJI 52 - 4	36 x 52	570	38	2	●						
<b>5611</b>	FUJI 52 numbering unit - gruppo numerazione	36 x 52	500	26	0,2					●		
<b>5615</b>	FUJI 58	-	620	53	2	●						
<b>5625</b>	FUJI 65/66	48 x 66	700	53	2	●						
<b>5616</b>	FUJI 74 flexible - flessibile	-	795	48	0,5	●						
<b>5617</b>	FUJI 74 rigid - rigida	-	795	48	2	●						
<b>5619</b>	FUJI 74 old model - modello vecchio	-	793	20	2		●					
<b>5627</b>	FUJI MTP LITOGRAFICA	-	1252	68	0,5	●						
<b>5637</b>	SHINOHARA 52 flexible - flessibile	36 x 50	550	43	0,5	●						
<b>5636</b>	SHINOHARA 52 rigid - rigida	36 x 50	550	43	2	●						
<b>5638</b>	SHINOHARA 52 plastic - plastica	36 x 50	530	30	1				●			
<b>5625</b>	SHINOHARA 66	48 x 66	700	53	2	●						
<b>5618</b>	SHINOHARA 75	-	780	30	1				●			
<b>5620</b>	SHINOHARA 79	-	835	48	0,5	●						

## GALLUS

Ref. Codice	Model Descrizione	Machine Size Dim. macchina	Lenght Lunghezza	Width Altezza	Thick. Spess.	Material / Materiale						€
						S+R F+G	Gomma Rubber	Teflon	Plastic Plastica	Other Altro		
<b>5907</b>	GALLUS R 160	-	222	38	0,5	●						
<b>6026</b>	GALLUS R 180	-	185	27	1				●			
<b>5928</b>	GALLUS R 200	-	250	38	0,5	●						
<b>5909</b>	GALLUS R 200	-	249	32	0,5	●						
<b>5929</b>	GALLUS R 250	-	320	60	0,5	●						
<b>5913</b>	GALLUS TCS 250	-	292	38	0,5	●						
<b>5908</b>	GALLUS R 300	-	362	58	0,5	●						
<b>5930</b>	GALLUS R 2.000	-	375	38	0,5	●						

## GESTETNER

Ref. Codice	Model Descrizione	Machine Size Dim. macchina	Lenght Lunghezza	Width Altezza	Thick. Spess.	Material / Materiale						€
						S+R F+G	Gomma Rubber	Teflon	Plastic Plastica	Other Altro		
<b>5670</b>	GESTETNER 210/211/311/411	-	260	38	1					●		
<b>5671</b>	GESTETNER 213/313/413	-	350	38	1					●		
<b>5672</b>	GESTETNER 152 SF	-	532	43	0,5	●						

## GIEBLER

Ref. Codice	Model Descrizione	Machine Size Dim. macchina	Lenght Lunghezza	Width Altezza	Thick. Spess.	Material / Materiale						€
						S+R F+G	Gomma Rubber	Teflon	Plastic Plastica	Other Altro		
<b>6011</b>	GIEBLER	-	550	25	5		●					
<b>6024</b>	GIEBLER R 55	-	580	25	5		●					

## GOEBEL

Ref. Codice	Model Descrizione	Machine Size Dim. macchina	Lenght Lunghezza	Width Altezza	Thick. Spess.	Material / Materiale						€
						S+R F+G	Gomma Rubber	Teflon	Plastic Plastica	Other Altro		
<b>5951</b>	GOEBEL ECOPRINT	-	590	58	0,5	●						
<b>5981</b>	GOEBEL OPTIFORMA 520	-	611	35	1				●			
<b>5978</b>	GOEBEL M 3300	-	391	35	1				●			

## HAMADA

Ref. Codice	Model Descrizione	Machine Size Dim. macchina	Lenght Lunghezza	Width Altezza	Thick. Spess.	Material / Materiale						€
						S+R F+G	Gomma Rubber	Teflon	Plastic Plastica	Other Altro		
<b>5778</b>	HAMADA 62 CD 2 <sup>ND</sup> UNIT - 2° GRUPPO	-	315	38	0,5	●						
<b>5779</b>	HAMADA ALFA 66	-	710	58	5		●					
<b>5780</b>	HAMADA 611 1 <sup>ST</sup> UNIT - 1° GRUPPO	-	335	45	5		●					
<b>5781</b>	HAMADA 611 2 <sup>ND</sup> UNIT - 2° GRUPPO	-	312	38	0,5	●						
<b>5780</b>	HAMADA DUETTO	-	335	45	5		●					
<b>5784</b>	HAMADA TOPRUNNER	-	276	48	5	●						
<b>5786</b>	HAMADA E47 1 <sup>ST</sup> UNIT - 1° GRUPPO	-	480	38	0,5	●						
<b>5785</b>	HAMADA E47 2 <sup>ND</sup> UNIT - 2° GRUPPO	-	487	45	5		●					
<b>5791</b>	HAMADA E47 - C52 E	-	555	38	0,5	●						
<b>5787</b>	HAMADA ALFA 248	-	518	43	0,5	●						
<b>5788</b>	HAMADA BETA 52	-	538	48	0,5	●						
<b>5789</b>	HAMADA ALFA 52	-	558	45	5		●					
<b>5797</b>	HAMADA B 252/452	-	570	38	0,5	●						
<b>5794</b>	HAMADA 234 C	-	358	48	0,5	●						
<b>5801</b>	HAMADA 500 CD	-	322	46	5		●					
<b>5792</b>	HAMADA 600 CD	-	335	48	0,5	●						
<b>5793</b>	HAMADA 700 E	-	478	45	5		●					
<b>5795</b>	HAMADA 700 CD	-	482	48	0,5	●						
<b>5796</b>	HAMADA 700 CD numbering - numerazione	-	491	53	0,5	●						
<b>5790</b>	HAMADA 700 DX	-	485	58	0,5	●						
<b>5802</b>	HAMADA 800 DX	-	544	45	5		●					
<b>5800</b>	HAMADA 900 CD	-	630	47	5		●					



# HAMILTON

Ref. Codice	Model Descrizione	Machine Size Dim. macchina	Lenght Lunghezza	Width Altezza	Thick. Spess.	Material / Materiale						€
						S+R F+G	Gomma Rubber	Teflon	Plastic Plastica	Other Altro		
<b>5987</b>	HAMILTON	-	565	35	5		●					
<b>6013</b>	HAMILTON STEVENS MULTI FEED	-	525	53	0,5	●						
<b>6014</b>	HAMILTON	-	735	58	0,5	●						

# HEIDELBERG

Ref. Codice	Model Descrizione	Machine Size Dim. macchina	Lenght Lunghezza	Width Altezza	Thick. Spess.	Material / Materiale						€
						S+R F+G	Gomma Rubber	Teflon	Plastic Plastica	Other Altro		
<b>5005</b>	PLATEN T - STELLA T	26 x 38	380	50	5	●						
<b>5010</b>	PLATEN G - STELLA GT	32 x 46	470	50	5	●						
<b>5015</b>	KS	38 x 52	530	46	1						●	
<b>5020</b>	KSB - KSBA (40x58,5 - 40x57 - 46x57)	46 x 58,5	575	46	1						●	
<b>5021</b>	TYPOGRAPHIC	50 x 70	720	46	1						●	
<b>5025</b>	OHZ	54 x 72	720	46	1						●	
<b>5030</b>	SBG - SB	56 x 77	770	46	1						●	
<b>5031</b>	SBG 2 <sup>ND</sup> UNIT - 2° GRUPPO	56 x 77	835	46	1						●	
<b>5035</b>	SBB	57 x 82	815	46	1						●	
<b>5040</b>	SBD	64 x 90	880	46	1						●	
<b>5100</b>	TOK	28 x 39	285	42	0,5	●						
<b>5115</b>	SORM rigid - rigida	52 x 72	790	53	2	●						
<b>5120</b>	SORM flexible - flessibile	52 x 74	790	60	0,5	●						
<b>5122</b>	SORMZ 2 <sup>ND</sup> UNIT - 2° GRUPPO	52 x 74	754	38	0,5	●						
<b>5135</b>	SORD rigid - rigida	64 x 90	960	53	2	●						
<b>5140</b>	SORD flexible - flessibile	64 x 91,5	960	60	0,5	●						
<b>5145</b>	SORK 65	48 x 65	720	53	2	●						
<b>5150</b>	SOR 82	61 x 82	890	53	2	●						
<b>5200</b>	SORS	72 x 102	1.090	60	0,5	●						
<b>5130</b>	SORS 2 <sup>ND</sup> UNIT - 2° GRUPPO	72 x 102	1.052	38	0,5	●						
<b>5155</b>	KOR 57	40 x 57	600	53	2	●						
<b>5160</b>	KORD 62	46 x 62	650	53	2	●						
<b>5165</b>	KORD 64	46 x 64	690	53	2	●						
<b>5170</b>	KORS 72	52 x 72	760	53	2	●						
<b>5175</b>	KORA 57	46 x 57	620	53	2	●						
<b>5176</b>	WEB 8 PAGES 12 COLORS	-	566	53	2	●						
<b>5180</b>	MO 65 - MOVP 65	48 x 65	710	60	0,5	●						
<b>5185</b>	MO 65 - MOVP 65 offset blankets	48 x 65	690	60	0,5	●						
<b>5187</b>	MO 65 - MOVP 65 numbering - numerazione	48 x 65	648	52	6						●	

## HEIDELBERG

Ref. Codice	Model Descrizione	Machine Size Dim. macchina	Lenght Lunghezza	Width Altezza	Thick. Spess.	Material / Materiale						€
						S+R F+G	Gomma Rubber	Teflon	Plastic Plastica	Other Altro		
5101	QUICKMASTER 46	34 x 46	376	44	4					●		
5105	GTO 46	32 x 46	500	60	0,5	●						
5107	GTO 46 numbering unit - gruppo numerazione	32 x 46	448	40	6						●	
5110	GTO 52 - PRINTMASTER 52	36 x 52	565	60	0,5	●						
5112	GTO 52 numbering unit - gruppo numerazione	36 x 52	508	40	6						●	
5205	GTO 52 APEX dampening unit - bagnatura APEX	36 x 52	557	25,5	12					●		
5189	PRINTMASTER 74 9+9 holes - 9+9 fori	52 x 74	826	58	0,5	●						
5193	SPEEDMASTER 52	36 x 52	605	48	0,5	●						
5194	SPEEDMASTER 52 numbering - numerazione	36 x 52	534	28	0,5	●						
5195	SPEEDMASTER 72	52 x 72	790	60	0,5	●						
5201	SPEEDMASTER 72 blankets baldwin	52 x 72	742	58	0,5	●						
5196	SPEEDMASTER 74	52 x 74	820	60	0,5	●						
5197	SPEEDMASTER 74	52 x 74	826	60	0,5	●						
5191	SPEEDMASTER 74 CD	52 x 74	847	45	0,5	●						
5192	SPEEDMASTER 74 CD - UV ink	52 x 74	847	45	3			●				
5200	SPEEDMASTER 102 holes - fori	72 x 102	1.090	60	0,5	●						
5202	SPEEDMASTER 102 CD slots - asole	72 x 102	1.090	60	0,5	●						
5198	SPEEDMASTER 102 - UV ink	72 x 102	1.090	60	3			●				
5204	SPEEDMASTER 102 blankets baldwin	72 x 102	1.042	58	0,5	●						
5130	SPEEDMASTER 102 2 <sup>ND</sup> UNIT - 2° GRUPPO	72 x 102	1.052	38	0,5	●						
5207	SPEEDMASTER XL 105	74 x 105	1.125	41	0,5	●						
5190	ROTASPEED 102	72 x 102	1.050	60	0,5	●						

## KBA (KOENING BAUER - ALBERT)

Ref. Codice	Model Descrizione	Machine Size Dim. macchina	Lenght Lunghezza	Width Altezza	Thick. Spess.	Material / Materiale						€
						S+R F+G	Gomma Rubber	Teflon	Plastic Plastica	Other Altro		
5249	KBA KARAT 46	-	390	25	5		●					
5212	KBA RAPIDA 72	72 x 52	780	48	0,5	●						
5220	KBA RAPIDA 104	72 x 104	1.130	48	0,5	●						
5210	KBA RAPIDA 105	72 x 105	1.140	48	0,5	●						
5250	KBA RAPIDA 106 / 105-P40	74 x 106	1.160	43	0,5	●						
5209	KBA RAPIDA 105 new model / nuovo mod.	72 x 105	1.160	37	0,5	●						
5211	KBA RAPIDA 142	102 x 142	1.510	65	0,5	●						
5252	KBA RAPIDA 145	106 x 145	1.540	55	0,5	●						
5244	KBA RAPIDA 162	120 x 162	1.700	65	0,5	●						
5229	KBA RAPIDA 162a	120 x 162	1.710	65	0,5	●						
5251	KBA RAPIDA 164	120 x 164	1.740	58	0,5	●						

# KBA (KOENING BAUER - ALBERT)

Ref. Codice	Model Descrizione	Machine Size Dim. macchina	Lenght Lunghezza	Width Altezza	Thick. Spess.	Material / Materiale						€
						S+R F+G	Gomma Rubber	Teflon	Plastic Plastica	Other Altro		
<b>5730</b>	KBA COMMANDER 60	-	1.640	68	1					●		
<b>5247</b>	KBA COMMANDER	-	1.520	95	0,5	●						
<b>5248</b>	KBA COMMANDER with bend / piegata	-	1.040	96	0,5	●						
<b>5219</b>	KBA 417 ROTOOFFSET	-	1.030	73	0,5	●						
<b>5213</b>	KBA ROTOOFFSET COMPACTA 40	-	1.026	68	0,5	●						
<b>5222</b>	KBA SRO 72	52 x 72	765	53	0,5	●						
<b>5231</b>	KBA SRO 72	52 x 72	770	51	1					●		
<b>5223</b>	KBA 617 ROTOOFFSET	-	1.516	73	0,5	●						
<b>5226</b>	KBA C 213 ROTOOFFSET	-	1.025	48	0,5	●						
<b>5224</b>	KBA COMPACTA	-	914	68	0,5	●						
<b>5227</b>	KBA REMBRANDT ROTOOFFSET 72	52 x 72	770	51	0,5	●						
<b>5228</b>	KBA REMBRANDT ROTOOFFSET 160	120 x 160	1.700	65	0,5	●						
<b>5734</b>	KBA PERFORMA 74	-	803	24	3					●		

# KOMORI

Ref. Codice	Model Descrizione	Machine Size Dim. macchina	Lenght Lunghezza	Width Altezza	Thick. Spess.	Material / Materiale						€
						S+R F+G	Gomma Rubber	Teflon	Plastic Plastica	Other Altro		
<b>5864</b>	LITHRONE/SPRINT 26 5 holes - 5 fori	48 x 66	727	43	0,5	●						
<b>5857</b>	LITHRONE/SPRINT 26 10 holes - 10 fori	48 x 66	706	48	0,5	●						
<b>5872</b>	LITHRONE/SPRINT 28 6 holes - 6 fori	52 x 72	785	38	0,5	●						
<b>5865</b>	LITHRONE/SPRINT 28 6 holes - 6 fori	52 x 72	785	43	0,5	●						
<b>5878</b>	LITHRONE/SPRINT 28 6 holes - 6 fori	52 x 72	785	35	2	●						
<b>5858</b>	LITHRONE/SPRINT 28 9 holes - 9 fori	52 x 72	780	43	0,5	●						
<b>5869</b>	LITHRONE/SPRINT 28 11 holes - 11 fori	52 x 72	766	43	0,5	●						
<b>5866</b>	LITHRONE/SPRINT 28 11 holes - 11 fori	52 x 72	766	48	0,5	●						
<b>5867</b>	LITHRONE/SPRINT 28 11 holes - 11 fori	52 x 72	775	48	0,5	●						
<b>5873</b>	LITHRONE S 228 6 holes - 6 fori	52 x 72	785	32	2	●						
<b>5870</b>	SPRINT NEW TYPE	-	720	53	2	●						
<b>5875</b>	SPRINT L 25 C	-	710	43	0,5	●						
<b>5876</b>	SPRINT L 225 B	-	720	53	0,5	●						
<b>5862</b>	KOMORI WEB LR438	-	1.060	48	0,5	●						

## KOMORI

Ref. Codice	Model Descrizione	Machine Size Dim. macchina	Lenght Lunghezza	Width Altezza	Thick. Spess.	Material / Materiale						€
						S-R F+G	Gomma Rubber	Teflon	Plastic Plastica	Other Altro		
5852	LITHRONE 20 8 holes - 8 fori	35 x 50	580	48	0,5	●						
5846	LITHRONE 20 5 holes - 5 fori	35 x 50	590	38	2	●						
5853	LITHRONE 40 8 holes - 8 fori	72 x 103	1.095	53	0,5	●						
5842	LITHRONE 40 12 holes - 12 fori	72 x 103	1.080	53	0,5	●						
5856	LITHRONE 40 15 holes - 15 fori	72 x 103	1.105	50	1				●			
5861	LITHRONE 40 14 holes - 14 fori	72 x 103	1.045	48	0,5	●						
5879	LITHRONE S40 SX 14 holes - 14 fori	72 x 103	1.065	50	1				●			
5844	LITHRONE 40 15 holes - 15 fori	72 x 103	1.076	48	0,5	●						
5845	LITHRONE 40 15 holes - 15 fori	72 x 103	1.082	50	0,5	●						
5843	LITHRONE 40 15 holes - 15 fori	72 x 103	1.111	48	0,5	●						
5859	LITHRONE 40 15 holes - 15 fori	72 x 103	1.110	50	1				●			
5847	LITHRONE 40 15 horizontal slots - 15 asole orizzontali	72 x 103	1.090	48	0,5	●						
5848	LITHRONE 40 15 vertical slots - 15 asole verticali	72 x 103	1.090	43	0,5	●						
5849	LITHRONE 44 17 holes - 17 fori	83 x 113	1.170	50	5		●					
5841	LITHRONE 44 17 holes - 17 fori	83 x 113	1.170	48	0,5	●						
5854	LITHRONE 44 17 holes - 17 fori	83 x 113	1.210	48	0,5	●						
5840	LITHRONE LS444 17 holes - 17 fori	83 x 113	1.230	50	1				●			
5850	LITHRONE 50 19 holes - 19 fori	96,5 x 128	1.380	48	0,5	●						
5851	LITHRONE 50 19 vertical slots - 19 asole verticali	96,5 x 128	1.376	48	0,5	●						
5871	LITHRONE S 29 11 holes - 11 fori	52 x 72	820	35	1				●			
5874	SPICA 29P 11 holes - 11 fori	52 x 72	806	40	1				●			

## MAILÄNDER

Ref. Codice	Model Descrizione	Machine Size Dim. macchina	Lenght Lunghezza	Width Altezza	Thick. Spess.	Material / Materiale						€
						S-R F+G	Gomma Rubber	Teflon	Plastic Plastica	Other Altro		
5680	MAILÄNDER 150 T	-	1.083	48	0,5	●						
5686	MAILÄNDER Y 160	-	1.220	60	0,5	●						
5681	MAILÄNDER 160/162	-	1.250	78	0,5	●						
5682	MAILÄNDER 162/122	-	1.259	78	0,5	●						
5679	MAILÄNDER 140	-	1.080	53	0,5	●						
5684	MAILÄNDER 460 coating/verniciatura	-	1.255	70	0,15					●		

# MANROLAND

Ref. Codice	Model Descrizione	Machine Size Dim. macchina	Lenght Lunghezza	Width Altezza	Thick. Spess.	Material / Materiale						€
						S+R F+G	Gomma Rubber	Teflon	Plastic Plastica	Other Altro		
<b>5225</b>	PRACTICA 00	35 x 50	555	68	0,5	●						
<b>5230</b>	PRACTICA 00 numbering unit - gruppo numerazione	35 x 50	520	38	0,5	●						
<b>5245</b>	PRACTICA 00 numbering bent - numerazione piegata	35 x 50	520	58	0,5	●						
<b>5235</b>	PRACTICA 01	48 x 66	705	68	0,5	●						
<b>5240</b>	PRACTICA 01 numbering unit - gruppo numerazione	48 x 66	670	38	0,5	●						
<b>5246</b>	PRACTICA 01 numbering bent - numerazione piegata	48 x 66	670	58	0,5	●						
<b>5235</b>	ROLAND 100	48 x 66	705	68	0,5	●						
<b>5253</b>	ROLAND 100	48 x 66	720	65	0,5	●						
<b>5255</b>	ROLAND 200 up to nr. 232 - fino nr. 232	52 x 72	785	65	0,5	●						
<b>5260</b>	ROLAND 200 over nr. 232 - oltre nr. 232	52 x 72	800	65	0,5	●						
<b>5265</b>	ROLAND 200 bicolor - bicolore	52 x 72	790	60	1					●		
<b>5257</b>	ROLAND 300	-	816	60	1					●		
<b>5259</b>	ROLAND MP 300	-	822	68	0,5	●						
<b>5267</b>	ROLAND 500 with slots / con asole	50 x 70	816	60	1					●		
<b>5268</b>	ROLAND 500 no holes / senza fori	50 x 70	815	40	1					●		
<b>5295</b>	ROLAND 600 lower grinding	72 x 102	1.100	65	0,5	●						
<b>5341</b>	ROLAND 600 upper grinding	72 x 102	1.090	65	0,5	●						
<b>5340</b>	ROLAND 700	70 x 100	1.090	65	0,5	●						
<b>5339</b>	ROLAND 700 13 holes - 13 fori	70 x 100	1.100	53	0,5	●						
<b>5337</b>	ROLAND 700	70 x 100	1.100	55	1					●		
<b>5338</b>	ROLAND 700	70 x 100	1.108	40	1					●		
<b>5343</b>	ROLAND 800 V / V W	92 x 130	1.410	65	0,5	●						
<b>5344</b>	ROLAND 800 VI back and front - fronte/retro	100 x 140	1.510	43	0,5	●						
<b>5345</b>	ROLAND 800 VI	100 x 140	1.510	65	0,5	●						
<b>5346</b>	ROLAND 800 VII / VII B	120 x 160	1.710	65	0,5	●						
<b>5336</b>	ROLAND 900	-	1.530	57	1					●		
<b>5258</b>	ROLAND FAVORIT 01	52 x 72	720	65	0,5	●						
<b>5260</b>	ROLAND FAVORIT 02 / OB	52 x 72	800	65	0,5	●						
<b>5270</b>	ROLAND PARVA I	56 x 83	900	65	0,5	●						
<b>5275</b>	ROLAND PARVA II	61 x 92	920	65	0,5	●						
<b>5280</b>	ROLAND PARVA II C	64 x 91,5	995	65	0,5	●						
<b>5285</b>	ROLAND REKORD III	65 x 96,5	1.043	65	0,5	●						
<b>5290</b>	ROLAND REKORD RVK III B	72 x 102	1.070	65	0,5	●						
<b>5295</b>	ROLAND REKORD RZK III B blu series - azzurra	72 x 102	1.100	65	0,5	●						
<b>5305</b>	ROLAND REKORD RWK III B grey series - grigia	72 x 102	1.132	65	0,5	●						
<b>5310</b>	ROLAND ULTRA IV 1 <sup>st</sup> model - 1° modello	78 x 108	1.145	65	0,5	●						
<b>5315</b>	ROLAND ULTRA IV 2 <sup>nd</sup> model - 2° modello	78 x 108	1.196	65	0,5	●						

# MANROLAND

Ref. Codice	Model Descrizione	Machine Size Dim. macchina	Lenght Lunghezza	Width Altezza	Thick. Spess.	Material / Materiale						€
						S+R F+G	Gomma Rubber	Teflon	Plastic Plastica	Other Altro		
<b>5320</b>	ROLAND ULTRA V	89 x 126	1.336	65	0,5	●						
<b>5322</b>	ROLAND ULTRA V W	92 x 130	1.340	65	0,5	●						
<b>5325</b>	ROLAND ULTRA VI	100 x 140	1.480	65	0,5	●						
<b>5335</b>	ROLAND ULTRA VII / VII B	120 x 160	1.675	65	0,5	●						
<b>5347</b>	M.A.N. 5 GS no holes - no fori	-	1.273	68	0,5	●						
<b>5349</b>	M.A.N. 5 GS 14 holes - 14 fori	-	1.280	70	0,5	●						
<b>5351</b>	M.A.N. ULTRA 127	-	1.412	30	5		●					
<b>5350</b>	M.A.N. G 140	100 x 140	1.540	60	0,5	●						
<b>5352</b>	M.A.N. GS H	-	1.433	78	0,5	●						
<b>5355</b>	M.A.N. G 160	120 x 160	1.749	78	0,5	●						
<b>5360</b>	M.A.N. GS 140	100 x 140	1.412	78	0,5	●						
<b>5365</b>	M.A.N. GS 160	120 x 160	1.614	78	0,5	●						
<b>5366</b>	M.A.N. 06 G	110 x 140	1.555	78	0,5	●						
<b>5364</b>	M.A.N. 06 G	110 x 140	1.570	30	5		●					
<b>5367</b>	M.A.N.	96 x 63	1.020	65	0,5	●						
<b>5353</b>	M.A.N.	-	1.535	65	0,5	●						
<b>5368</b>	ROTOMAN WEB OFFSET	96 x 63	1.060	65	0,5	●						
<b>5363</b>	ROTOMAN 40	-	1.040	65	0,5	●						
<b>5362</b>	ROTOMAN C	-	1.039	65	0,5	●						
<b>5369</b>	COLORMAN	-	1.400	65	0,5	●						
<b>5370</b>	LITHO M.A.N.	-	1.552	65	0,5	●						
<b>5371</b>	LITHO M.A.N.	-	1.700	65	0,5	●						
<b>5373</b>	LITHO M.A.N. 64 PAGES - 64 PAGINE	-	1.980	65	0,5	●						
<b>5377</b>	LITHO M.A.N. 80 PAGES - 80 PAGINE	-	1.066	65	0,5	●						
<b>5376</b>	LITHO M.A.N. 11	-	2.060	65	0,5	●						
<b>5372</b>	ULTRA M.A.N.	-	1.620	52	3			●				
<b>5729</b>	ROLAND PERLE COLOR	50 x 70	1.000	65	0,5	●						
<b>5988</b>	OCTOMAN	-	745	53	0,5	●						

# MILLER

Ref. Codice	Model Descrizione	Machine Size Dim. macchina	Lenght Lunghezza	Width Altezza	Thick. Spess.	Material / Materiale						€
						S+R F+G	Gomma Rubber	Teflon	Plastic Plastica	Other Altro		
<b>5805</b>	MILLER TP 74 S.C. 29 - S.C. 74	52 x 74	820	68	0,5	●						
<b>5810</b>	MILLER TP 92 / TP 32	61 x 82	920	68	0,5	●						
<b>5815</b>	MILLER TP 94 / TP 36	65 x 94	1.022	68	0,5	●						
<b>5820</b>	MILLER TP 38	65 x 97,5	1.092	78	0,5	●						
<b>5825</b>	MILLER TP 104 / TP 41s	72 x 104	1.140	68	0,5	●						

# MITSUBISHI

Ref. Codice	Model Descrizione	Machine Size Dim. macchina	Lenght Lunghezza	Width Altezza	Thick. Spess.	Material / Materiale						€
						S+R F+G	Gomma Rubber	Teflon	Plastic Plastica	Other	Altro	
<b>5890</b>	MITSUBISHI 1E	50 x 70	784	40	2				●			
<b>5885</b>	MITSUBISHI 1F	50 x 70	778	33	0,5	●						
<b>5891</b>	MITSUBISHI 1F	50 x 70	778	36	5				●			
<b>5889</b>	MITSUBISHI 1G	50 x 70	786	38	0,5	●						
<b>5894</b>	MITSUBISHI 3F	70 x 100	1.186	38	0,5	●						
<b>5886</b>	MITSUBISHI 3F / 3G	70 x 100	1.090	38	0,5	●						
<b>5892</b>	MITSUBISHI 3H	70 x 100	1.100	43	0,5	●						
<b>5887</b>	MITSUBISHI 5F / 5G	90 x 130	1.366	43	0,5	●						
<b>5888</b>	MITSUBISHI 6F / 6G	100 x 140	1.506	43	0,5	●						
<b>5893</b>	MITSUBISHI DIAMOND 3000	70 x 100	1.095	38	0,5	●						
<b>5896</b>	MITSUBISHI DIAMOND V3000	75 x 105	1.126	38	0,5	●						

# MIYAKOSHI

Ref. Codice	Model Descrizione	Machine Size Dim. macchina	Lenght Lunghezza	Width Altezza	Thick. Spess.	Material / Materiale						€
						S+R F+G	Gomma Rubber	Teflon	Plastic Plastica	Other	Altro	
<b>6000</b>	MIYAKOSHI DIR 15	-	465	56	5					●		
<b>6001</b>	MIYAKOSHI MSP 18 MVF double - doppia	-	526	56	5					●		
<b>5962</b>	MIYAKOSHI MSP 18 DVF	-	503	35	5					●		
<b>5963</b>	MIYAKOSHI MSP 18 DVR	-	521	38	5					●		
<b>6002</b>	MIYAKOSHI MVF 20	-	588	60	5					●		
<b>6003</b>	MIYAKOSHI MVF 22	-	637	56	4					●		
<b>5964</b>	MIYAKOSHI	-	526	56	5					●		
<b>5965</b>	MIYAKOSHI MK continuos form - modulo continuo	-	527	50	5		●					

# MÜLLER MARTINI

Ref. Codice	Model Descrizione	Machine Size Dim. macchina	Lenght Lunghezza	Width Altezza	Thick. Spess.	Material / Materiale						€
						S+R F+G	Gomma Rubber	Teflon	Plastic Plastica	Other	Altro	
<b>5943</b>	MÜLLER MARTINI PRONTO 42 2.200	-	458	38	0,5	●						
<b>5971</b>	MÜLLER MARTINI GRAPH A old - vecchio mod.	-	530	40	3				●			
<b>5944</b>	MÜLLER MARTINI GRAPH A 50/20,5"	-	529	38	0,5	●						
<b>5944</b>	MÜLLER MARTINI GRAPH A 520/R667	-	529	38	0,5	●						
<b>5945</b>	MÜLLER MARTINI GRAPH A 84/32"	-	835	43	0,5	●						
<b>5945</b>	MÜLLER MARTINI PROGRESS 50 20S	-	835	43	0,5	●						
<b>5946</b>	MÜLLER A74	-	783	38	0,5	●						
<b>5986</b>	MÜLLER "0" TYPE	-	528	38	0,5	●						

## MULTILITH

Ref. Codice	Model Descrizione	Machine Size Dim. macchina	Lenght Lunghezza	Width Altezza	Thick. Spess.	Material / Materiale						€
						S+R F+G	Gomma Rubber	Teflon	Plastic Plastica	Other Altro		
<b>5882</b>	MULTILITH 1250	-	270	20	5		●					
<b>5883</b>	MULTILITH 1250	-	274	48	0,5	●						
<b>5884</b>	MULTILITH 1650	-	330	28	0,5				●			
<b>5881</b>	MULTILITH 1860	-	500	20	5		●					

## NEBIOLO

Ref. Codice	Model Descrizione	Machine Size Dim. macchina	Lenght Lunghezza	Width Altezza	Thick. Spess.	Material / Materiale						€
						S+R F+G	Gomma Rubber	Teflon	Plastic Plastica	Other Altro		
<b>5060</b>	SUPEREGERIA	-	590	45	0,2					●		
<b>5065</b>	ATENA	-	780	45	0,2					●		
<b>5070</b>	SATURNIA	-	960	45	0,2					●		
<b>5705</b>	INVICTA 26/226/28/228	-	935	51	1				●			
<b>5706</b>	INVICTA 128	-	830	51	1				●			
<b>5710</b>	INVICTA 32/33/36/38/238	-	1.135	51	1				●			
<b>5715</b>	INVICTA 44	78 x 112	1.165	51	1				●			
<b>5716</b>	INVICTA 44S	78 x 112	1.200	51	1				●			
<b>5720</b>	INVICTA 63-140	120 x 160	1.660	51	1				●			
<b>5721</b>	INVICTA 41 S	72 x 112	1.140	42	0,5	●						
<b>5723</b>	NEBIOLO ROTOOFFSET	120 x 160	1.650	60	3,5			●				
<b>5736</b>	NEBIOLO COLORA 6000	-	1.474	65	0,5	●						
<b>5723</b>	NEBIOLO 63 K/L - COLORA 8000	120 x 160	1.650	60	3,5			●				

## PLANETA

Ref. Codice	Model Descrizione	Machine Size Dim. macchina	Lenght Lunghezza	Width Altezza	Thick. Spess.	Material / Materiale						€
						S+R F+G	Gomma Rubber	Teflon	Plastic Plastica	Other Altro		
<b>5440</b>	PLANETA 4	70 x 100	1.060	60	5					●		
<b>5445</b>	PLANETA 6	90 x 127	1.350	60	5					●		
<b>5443</b>	PLANETA 142	100 x 140	1.483	60	5					●		
<b>5450</b>	PLANETA 7	100 x 140	1.510	60	5					●		
<b>5455</b>	PLANETA 8/8A	120 x 162	1.710	60	5					●		
<b>5440</b>	PLANETA SUPERVARIANT 4/6	70 x 100	1.060	60	5					●		
<b>5441</b>	PLANETA VARIMAT	-	1.150	68	0,5	●						
<b>5442</b>	PLANETA BRILLANT SP 01	50 x 70	800	65	0,5	●						



# ROTAPRINT

Ref. Codice	Model Descrizione	Machine Size Dim. macchina	Lenght Lunghezza	Width Altezza	Thick. Spess.	Material / Materiale						€
						S+R	F+G	Gomma Rubber	Teflon	Plastic Plastica	Other Altro	
<b>5905</b>	ROTAPRINT R14 CS2 continuo form - mod. continuo	-	460	28	1					●		
<b>5906</b>	ROTAPRINT R14 continuo form - modulo continuo	-	466	31	0,5	●						
<b>5910</b>	ROTAPRINT R45K	25 x 35	295	28	1					●		
<b>5915</b>	ROTAPRINT R35K/R36K/R37K	35 x 50	495	28	1					●		
<b>5920</b>	ROTAPRINT R35KV/R36KV/R37KV	35 x 50	538	28	1					●		
<b>5921</b>	ROTAPRINT R35KV/R30SK	35 x 50	514	35	5			●				
<b>5918</b>	ROTAPRINT ENGLISH R38/50 NP	35 x 50	510	34	5			●				

# ROTATEK

Ref. Codice	Model Descrizione	Machine Size Dim. macchina	Lenght Lunghezza	Width Altezza	Thick. Spess.	Material / Materiale						€
						S+R	F+G	Gomma Rubber	Teflon	Plastic Plastica	Other Altro	
<b>5931</b>	ROTATEK 100	-	414	43	0,5	●						
<b>5917</b>	ROTATEK MP-150	-	442	58	0,5	●						
<b>5932</b>	ROTATEK 200	-	539	60	0,5	●						
<b>5933</b>	ROTATEK 300 / 400	-	584	53	0,5	●						
<b>5903</b>	ROTATEK 300 / 400 rubber - gomma	-	584	50	5			●				
<b>5919</b>	ROTATEK 300 / 400	-	580	58	0,5	●						
<b>5877</b>	ROTATEK SRS - 45 BRAVA	-	492	58	0,5	●						

# RYOBI

Ref. Codice	Model Descrizione	Machine Size Dim. macchina	Lenght Lunghezza	Width Altezza	Thick. Spess.	Material / Materiale						€
						S+R	F+G	Gomma Rubber	Teflon	Plastic Plastica	Other Altro	
<b>5640</b>	RYOBI 2.700 / 2.800	-	305	41	5			●				
<b>5641</b>	RYOBI 3.304 H	-	364	40	5			●				
<b>5642</b>	RYOBI 3.200 1 <sup>ST</sup> UNIT - 1° GRUPPO	-	355	41	5			●				
<b>5643</b>	RYOBI 3.202 2 <sup>ND</sup> UNIT - 2° GRUPPO	-	353	25	5			●				
<b>5644</b>	RYOBI 480 KA / 500K	-	510	45	5			●				
<b>5646</b>	RYOBI 480 KANP / 500KNP	-	524	35	0,5	●						
<b>5652</b>	RYOBI 500 N	-	504	45	5			●				
<b>5647</b>	RYOBI 510 / 512	-	557	29	5			●				
<b>5654</b>	RYOBI 512	-	560	25	5			●				
<b>5660</b>	RYOBI 520 / 522 / 524	-	573	25	5			●				
<b>5658</b>	RYOBI 520 NP / 522 NP / 524 NP	-	545	48	0,5	●						
<b>5662</b>	RYOBI 530 / 560	-	602	39	5			●				
<b>5661</b>	RYOBI 4502 MCS	-	454	42	5			●				
<b>5664</b>	RYOBI 640	-	736	45	5			●				
<b>5648</b>	RYOBI 662 PF	-	760	42	5			●				
<b>5653</b>	RYOBI 750	-	855	34	5			●				

# SAKURAI

Ref. Codice	Model Descrizione	Machine Size Dim. macchina	Lenght Lunghezza	Width Altezza	Thick. Spess.	Material / Materiale						€
						S+R F+G	Gomma Rubber	Teflon	Plastic Plastica	Other Altro		
<b>5217</b>	SAKURAI OLIVER 6	32 x 48	530	50	5		●					
<b>5215</b>	SAKURAI OLIVER 66	46 x 66	730	50	5		●					
<b>5241</b>	SAKURAI OLIVER 66	46 x 66	762	50	5		●					
<b>5239</b>	SAKURAI OLIVER 66 EZ	46 x 66	715	50	5		●					
<b>5218</b>	SAKURAI OLIVER 52	36 x 52	570	50	5		●					
<b>5242</b>	SAKURAI OLIVER 52 numbering unit - gr. numeraz.	36 x 52	570	24	0,2						●	
<b>5243</b>	SAKURAI OLIVER 252	36 x 52	620	50	5		●					
<b>5216</b>	SAKURAI OLIVER 58	44 x 58	620	50	5		●					
<b>5214</b>	SAKURAI OLIVER 72	52 x 72	800	50	5		●					
<b>5233</b>	SAKURAI OLIVER 82	-	872	50	5		●					
<b>5238</b>	SAKURAI OLIVER 75 SD	-	880	50	3		●					

# SOLNA

Ref. Codice	Model Descrizione	Machine Size Dim. macchina	Lenght Lunghezza	Width Altezza	Thick. Spess.	Material / Materiale						€
						S+R F+G	Gomma Rubber	Teflon	Plastic Plastica	Other Altro		
<b>5700</b>	SOLNA C 96	-	1.065	22	3		●					
<b>5701</b>	SOLNA 124 / 125 / 425	-	700	22	3		●					
<b>5698</b>	SOLNA 164 / 566	-	710	22	3		●					
<b>5702</b>	SOLNA 72	72 x 102	810	22	3		●					
<b>5703</b>	SOLNA 240	-	1.160	22	3		●					

# TARGET

Ref. Codice	Model Descrizione	Machine Size Dim. macchina	Lenght Lunghezza	Width Altezza	Thick. Spess.	Material / Materiale						€
						S+R F+G	Gomma Rubber	Teflon	Plastic Plastica	Other Altro		
<b>5722</b>	TARGET I / II WEB mod. 22/23/25	-	1.075	53	0,5	●						
<b>5719</b>	TARGET III 47" / 52"	-	1.075	88	0,5	●						

## TIMSONS

Ref. Codice	Model Descrizione	Machine Size Dim. macchina	Lenght Lunghezza	Width Altezza	Thick. Spess.	Material / Materiale						€
						S+R F+G	Gomma Rubber	Teflon	Plastic Plastica	Other Altro		
<b>6007</b>	TIMSON MULTIROLL	-	605	70	5					●		
<b>6030</b>	TIMSON T24	-	549	53	0,5	●						
<b>6008</b>	TIMSON T32 40"	-	1.080	53	0,5	●						
<b>6009</b>	TIMSON T32 47"	-	1.258	53	0,5	●						
<b>6010</b>	TIMSON T32 53"	-	1.410	53	0,5	●						
<b>6033</b>	TIMSON T48	-	1.330	53	0,5	●						
<b>6028</b>	TIMSON 135	-	1.510	53	0,5	●						

## TISON

Ref. Codice	Model Descrizione	Machine Size Dim. macchina	Lenght Lunghezza	Width Altezza	Thick. Spess.	Material / Materiale						€
						S+R F+G	Gomma Rubber	Teflon	Plastic Plastica	Other Altro		
<b>5939</b>	TISON FLEXI 10	-	505	45	3			●				
<b>5948</b>	TISON FLEXI 11	-	500	60	0,5	●						
<b>7009</b>	TISON FLEXI 12	-	500	19	5	●						
<b>7001</b>	TISON ST 150	-	460	19	5	●						

## VARIOUS / VARIE

Ref. Codice	Model Descrizione	Machine Size Dim. macchina	Lenght Lunghezza	Width Altezza	Thick. Spess.	Material / Materiale						€
						S+R F+G	Gomma Rubber	Teflon	Plastic Plastica	Other Altro		
<b>5980</b>	BIELOMATIK	-	625	32	5		●					
<b>5970</b>	C.M.C. CARDANI	-	570	43	0,5	●						
<b>5976</b>	CELLINI CALCOGRAPHIC - CALCOGRAFICA	-	594	48	0,5	●						
<b>5993</b>	DAINIPPON SCREEN KF-123-GL	-	1.100	40	5			●				
<b>6019</b>	DAINIPPON SCREEN KF-124-GL	-	1.100	53	3			●				
<b>7002</b>	HASHIMOTO IMPULSE 22 - SA552 P	-	620	58	0,5	●						
<b>5969</b>	KO-PAK 250	-	280	43	0,5	●						
<b>5995</b>	KORREX MAX SIMMEL PRESS OFFSET	-	1.036	40	5				●			
<b>5735</b>	PRESSTEK 52DI	-	577	25	5			●				
<b>5968</b>	SCHRIBBER 500	-	515	53	0,5	●						
<b>6015</b>	STEVENS 4B continuous form - modulo continuo	-	530	48	0,5	●						
<b>5999</b>	UKITA	-	420	43	0,5	●						
<b>5991</b>	W&D 212	-	473	48	0,5	●						

## DAVIDSON

Ref. Codice	Model Descrizione	Machine Size Dim. macchina	Jacket size Dim. piastra	Thick. Spess.	Material / Materiale					€
					Steel Acciaio	Hard Steel	Brass	Offone	Nylon	
<b>9381</b>	DAVIDSON 501	25 x 35	252 x 391	0,3	●					
<b>9383</b>	DAVIDSON 501	45 x 37	438 x 390	0,3	●					
<b>9382</b>	DAVIDSON 701	35 x 50	503 x 408	0,3	●					

## FUJI - SHINOHARA

<b>9360</b>	FUJI / SHINOHARA 52 steel - acciaio	36 x 52	518 x 392	0,3	●					
<b>9359</b>	FUJI / SHINOHARA 52 brass - ottone	36 x 52	519 x 392	0,3			●			
<b>9361</b>	FUJI / SHINOHARA 52 nylon	36 x 52	519 x 392	0,5				●		
<b>9358</b>	FUJI 52 new model - nuovo modello	36 x 52	520 x 367	0,3	●					
<b>9362</b>	FUJI SHINOHARA 66	48 x 66	666 x 516	0,3	●					
<b>9304</b>	FUJI 52 counter driller - controperforatore	48 x 66	390 x 7	0,5	●					

## HAMADA

<b>9355</b>	HAMADA ALFA 52	35 x 52	513 x 400	0,3	●					
<b>9357</b>	HAMADA ALFA 66	-	654 x 532	0,3	●					

## KOENING E BAUER

<b>9363</b>	KOENING & BAUER	72 x 102	1.050 x 743	0,4	●					
-------------	-----------------	----------	-------------	-----	---	--	--	--	--	--

## ROTAPRINT

<b>9350</b>	ROTAPRINT R37KV	35 x 50	487 x 348	0,3	●					
-------------	-----------------	---------	-----------	-----	---	--	--	--	--	--

## HORAUF

<b>9340</b>	HORAUF COVERING MACHINE	-	710 x 415	0,3	●					
<b>9341</b>	HORAUF COVERING MACHINE old model - tipo vecchio	-	710 x 390	0,3	●					
<b>9342</b>	HORAUF COVERING MACHINE	-	710 x 415	0,3	●					

## HEIDELBERG

Ref. Codice	Model Descrizione	Machine Size Dim. macchina	Jacket size Dim. piastra	Thick. Spess.	Material / Materiale					€
					Steel Acciaio	Hard Steel	Brass Ottone	Nylon		
9405	QUICKMASTER 46	34 x 46	347 x 496	0,3		●				
9403	GTO 46 steel - acciaio	32 x 46	458 x 393	0,3		●				
9404	GTO 46 brass - ottone	32 x 46	458 x 393	0,3			●			
9402	GTO 46 nylon	32 x 46	458 x 413	0,5				●		
9407	GTO / PRINTMASTER 52 steel - acciaio	36 x 52	518 x 407	0,3		●				
9408	GTO / PRINTMASTER 52 brass - ottone	36 x 52	518 x 407	0,3			●			
9406	GTO / PRINTMASTER 52 nylon	36 x 52	518 x 413	0,5				●		
9410	MO 65 nylon	48 x 65	659 x 547	0,5				●		
9411	MO 65 steel - acciaio	48 x 65	659 x 547	0,3	●					
9412	MO 65 brass - ottone	48 x 65	659 x 547	0,3			●			
9409	SPEEDMASTER 52 steel - acciaio	36 x 52	530 x 390	0,3		●				
9415	SPEEDMASTER 52 brass - ottone	36 x 52	530 x 390	0,3			●			
9417	SPEEDMASTER 52 nylon	36 x 52	530 x 390	0,5				●		
9413	SPEEDMASTER 72 steel - acciaio	52 x 72	738 x 533	0,3	●					
9421	SPEEDMASTER 72 nylon	52 x 72	738 x 533	0,5				●		
9494	SPEEDMASTER 72 transfer - trasferimento	52 x 72	749 x 530	0,3	●					
9400	SPEEDMASTER 74	52 x 74	753 x 532	0,3	●					
9470	SPEEDMASTER 74 transfer - trasferimento	52 x 74	810 x 530	0,3	●					
9401	SPEEDMASTER 102	72 x 102	1.036 x 710	0,3	●					
9401	SORS	72 x 102	1.036 x 710	0,3	●					
9414	KOR 57	40 x 57	573 x 400	0,5	●					
9416	KORA 57	46 x 57	573 x 454	0,5	●					
9418	KORD 62	46 x 62	625 x 450	0,5	●					
9420	KORD 64	46 x 64	650 x 460	0,5	●					
9422	KORS 72	52 x 72	725 x 520	0,5	●					

## KOMORI

9373	SPRINT 25	-	734 x 576	0,3	●					
9375	SPRINT 25 nylon	-	734 x 576	0,5				●		
9370	SPRINT 26	46 x 88	677 x 562	0,3	●					
9376	SPRINT 28	52 x 72	734 x 576	0,3	●					
9377	SPRINT II 28 / SPRINT 28 GS	52 x 72	734 x 586	0,3	●					

# MANROLAND

Ref. Codice	Model Descrizione	Machine Size Dim. macchina	Jacket size Dim. piastra	Thick. Spess.	Material / Materiale					€
					Steel Acciaio	Hard Hiera	Steel Steel	Brass Ottone	Nylon	
<b>9423</b>	PRACTICA 00 up to nr. 134 - fino matr. 134	35 x 50	509 x 393	0,3	●					
<b>9424</b>	PRACTICA 00 over nr. 134 - oltre matr. 134 / steel - acciaio	35 x 50	510 x 385	0,3	●					
<b>9429</b>	PRACTICA 00 over nr. 134 - oltre matr. 134 / brass - ottone	35 x 50	510 x 385	0,3			●			
<b>9458</b>	PRACTICA 00 over nr. 134 - oltre matr. 134 / nylon	35 x 50	510 x 385	0,5				●		
<b>9455</b>	PRACTICA 00 two colors (bend 45°) - bicolore (piega 45°)	35 x 50	510 x 385	0,3	●					
<b>9425</b>	PRACTICA 01 over nr. 163 - oltre matr. 163	48 x 66	660 x 492	0,3	●					
<b>9426</b>	PRACTICA 01 up to nr. 163 - fino matr. 163	48 x 66	660 x 473,5	0,3	●					
<b>9459</b>	ROLAND RVF OB	52 x 72	730 x 608	0,3	●					

# RYOBI

<b>9468</b>	RYOBI 520	-	482 x 362	0,3		●				
<b>9492</b>	RYOBI 520 NP	-	525 x 415	0,3		●				
<b>9493</b>	RYOBI 522 NP	-	523 x 414	0,5		●				
<b>9469</b>	RYOBI 750	50 x 70	820 x 548	0,5	●					
<b>9302</b>	RYOBI counter driller - controperforatore	-	410 x 12	0,3	●					
<b>9303</b>	RYOBI counter driller - controperforatore	-	410 x 32	0,3	●					

# SAKURAI

<b>9365</b>	OLIVER 52	36 x 52	525 x 408	0,3	●					
<b>9366</b>	OLIVER 6	32 x 48	485 x 389	0,3	●					
<b>9367</b>	OLIVER 58 steel - acciaio	44 x 58	580 x 495	0,3	●					
<b>9371</b>	OLIVER 58 nylon	44 x 58	580 x 495	0,5				●		
<b>9368</b>	OLIVER 66	46 x 66	668 x 543	0,3	●					
<b>9378</b>	OLIVER 66 EZ	46 x 66	673 x 510	0,3	●					
<b>9369</b>	OLIVER 72	52 x 72	725 x 585	0,3	●					

# TOKO

<b>9364</b>	TOKO	-	315 x 496	0,2	●					
-------------	------	---	-----------	-----	---	--	--	--	--	--

# Super Blue Original Nets

Ref. Codice	Description Descrizione	Measure Misura	€
<b>9714</b>	SUPERBLU 40" - 102 cm	6/ROLL - 6 TELI	
<b>9736</b>	SUPERBLU 28" - 72 cm	6/ROLL - 6 TELI	

## Blue Glass Jackets

ANTI MARKING TRANSFER JACKETS (BLUE)  
CAMICIE SILICONATE PER CILINDRI DI TRASFERIMENTO (BLU)

Ref. Codice	Description Descrizione	€
<b>9810</b>	HEIDELBERG SM 102 RIVETS & LOOPS - BOTTONI+ASTINA POST 1994/5 - DOPO 5/1994	
<b>9812</b>	HEIDELBERG SM 102 LOOPS & LOOPS - ASTINA+ASTINA PRE 1994/5 - PRIMA 5/1994	
<b>9814</b>	HEIDELBERG SM 102 DELIVERY - USCITA Size required - dimensioni necessarie	
<b>9816</b>	HEIDELBERG SM 74	
<b>9818</b>	HEIDELBERG SM 74 DELIVERY - USCITA Size required - dimensioni necessarie	
<b>9820</b>	HEIDELBERG SM 72	
<b>9822</b>	HEIDELBERG SM 72 DELIVERY - USCITA Size required - dimensioni necessarie	
<b>9824</b>	HEIDELBERG MO	
<b>9826</b>	HEIDELBERG SM 52	
<b>9828</b>	HEIDELBERG SM 52 DELIVERY - USCITA	
<b>9830</b>	HEIDELBERG GTO 52	

## PrintGuard & PrintGuardPlus Film

ANTI MARKING FILM  
PELLICOLA IDROREPELENTE

Ref. Codice	Description Descrizione	Measure Dimensioni	€
<b>9840</b>	Shinoda ICP WHITE NON ADHESIVE FOR GENERAL PAPER Shinoda ICP BIANCO NON ADESIVO PER CARTA	L: 1.050 mm each meter - ogni metro	
<b>9844</b>	Shinoda ICP WHITE NON ADHESIVE FOR CARDBOARD Shinoda ICP BIANCO NON ADESIVO PER CARTONE	L: 1.050 mm each meter - ogni metro	
<b>9846</b>	SuperSEE WHITE ADHESIVE SuperSEE BIANCO ADESIVO	L: 1.050 mm each meter - ogni metro	
<b>9850</b>	PrintGuardPlus ORANGE NON ADHESIVE PrintGuardPlus ARANCIONE NON ADESIVO	L: 1.050 mm each meter - ogni metro	
<b>9852</b>	PrintGuardPlus ORANGE ADHESIVE PrintGuardPlus ARANCIONE ADESIVO	L: 1.050 mm each meter - ogni metro	

# ALBERT

Ref. Codice	Model Descrizione	Machine Size Dim. macchina	Jacket size Dim. piastra	Thick. Spess.	Material / Materiale					€
					Steel Acciaio	Hard Steel	Brass	Other	Nylon	
<b>9480</b>	ALA EXP.	38 X 57	580 x 390	0,8	●					
<b>9481</b>	ALA	40 x 58	585 x 405	0,8	●					
<b>9482</b>	GRALA	52 x 72	700 x 500	0,8	●					
<b>9483</b>	GRALA EXP.	56 x 76	760 x 550	0,8	●					
<b>9484</b>	GRALA	56 x 80	775x 540	0,8	●					
<b>9485</b>	PRESIDENT	70 x 101	1.020 x 690	0,8	●					
<b>9486</b>	PRESIDENT G.M.	75 x 105	1.050 x 750	0,8	●					
<b>9488</b>	SENATOR	84 x 112	1.130 x 820	0,8	●					

# HEIDELBERG

<b>9427</b>	PLATEN T - STELLA T	26 x 38	362 x 260	0,8		●				
<b>9428</b>	PLATEN GT - STELLA GT	32 x 46	451 x 335	0,8		●				
<b>9471</b>	BED (CHASE) T - CONTROPRESSIONE T	26 x 38	363 x 253	0,8	●					
<b>9472</b>	BED (CHASE) GT - CONTROPRESSIONE GT	32 x 46	452 x 327	0,8	●					
<b>9490</b>	PLATEN GT - STELLA GT 2 mm	32 x 46	453 x 327	2,0		●				
<b>9491</b>	PLATEN GT - STELLA GT 3 mm	32 x 46	453 x 327	3,0		●				
<b>9430</b>	KS	38 x 52	525 x 375	0,8	●					
<b>9431</b>	KSBA	46 x 57	570 x 450	0,8		●				
<b>9432</b>	KSBA	46 x 58,5	585 x 450	0,8		●				
<b>9433</b>	KSB	40 x 58,5	583 x 397	0,8		●				
<b>9434</b>	KSB	40 x 57	570 x 400	0,8		●				
<b>9435</b>	KSD	46 x 64	650 x 460	0,8		●				
<b>9436</b>	OHZ - S	54 x 72	720 x 535	0,8		●				
<b>9437</b>	SBG 0,6 mm	56 x 77	770 x 560	0,6	●					
<b>9438</b>	SBG 0,8 mm	56 x 77	770 x 560	0,8		●				
<b>9460</b>	SBG - SB	54 x 77	770 x 550	0,8		●				
<b>9439</b>	HEIDELBERG OLD	51 x 70	700 x 513	0,8		●				
<b>9440</b>	SBB	57 x 82	820 x 560	0,8		●				
<b>9441</b>	SBD	64 x 89	885 x 632	0,8	●					
<b>9442</b>	SBD	64 x 90	895 x 632	0,8	●					



# JOHANNISBERG

Ref. Codice	Model Descrizione	Machine Size Dim. macchina	Jacket size Dim. piastra	Thick. Spess.	Material / Materiale					€
					Steel Acciaio	Hard Steel	Brass	Aluminum Alluminio	Nylon	
<b>9461</b>	JOHANNISBERG	56 x 76	745 x 520	0,8	●					
<b>9462</b>	JOHANNISBERG SELEKTA	57 x 80	820 x 580	0,8	●					
<b>9463</b>	JOHANNISBERG 82	58 x 84	820 x 600	0,8	●					
<b>9465</b>	JOHANNISBERG S 104	75 x 104	1.050 x 730	0,8	●					

# KOENING & BAUER

<b>9474</b>	KOENING & BAUER CONDOR	70 x 102	1.000 x 710	0,8	●					
-------------	------------------------	----------	-------------	-----	---	--	--	--	--	--

# NEBIOLO

<b>9443</b>	EGERIA	40 x 56	560 x 400	0,8	●					
<b>9444</b>	SUPER EGERIA	45 x 57	580 x 415	0,8	●					
<b>9466</b>	SUPER EGERIA	45 x 57	580 x 435	0,8	●					
<b>9445</b>	ATENA	56 x 79	790 x 550	0,8	●					
<b>9446</b>	URANIA	76 x 112	1.110 x 790	0,8	●					
<b>9447</b>	URANIA G.M.	80 x 112	1.140 x 785	0,8	●					
<b>9448</b>	SATURNIA	65 x 96	970 x 630	0,8	●					
<b>9449</b>	MUSSANO E SISTO	40 x 65	575 x 375	0,8	●					
<b>9450</b>	MUSSANO E SISTO INTREPIDA ULTRA	46 x 65	692 x 488	0,8	●					
<b>9451</b>	MUSSANO E SISTO UNIGRAF	52 X 72	720 X 512	0,8	●					
<b>9452</b>	NEBIOLO RAPIDA DI LUSO	50 x 70	735 x 510	0,8	●					
<b>9453</b>	BRILLI E FERRANDO	50 x 70	750 x 520	0,8	●					
<b>9454</b>	AIRUNDO	35 x 50	540 x 395	0,8	●					
<b>9456</b>	PLANETA (VICTORIA 1040)	70 x 100	1.047 x 740	0,8	●					

# INK DUCT STOP PLATES

# SPALLE DEL CALAMAIO

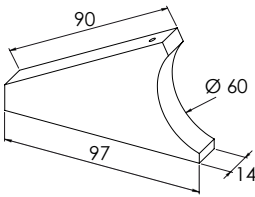
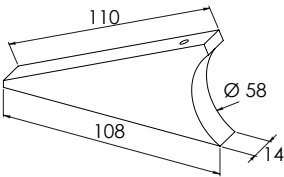
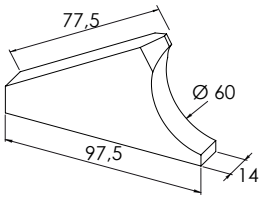
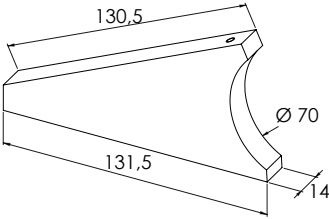
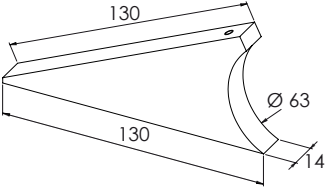
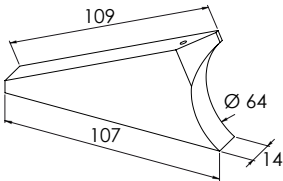
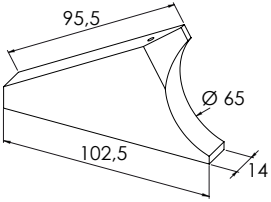
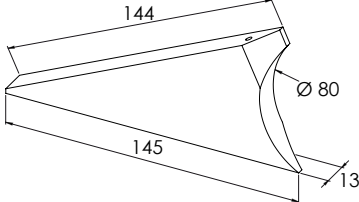
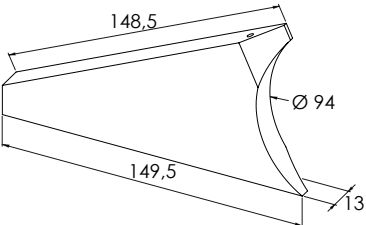
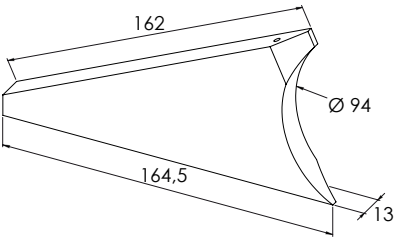
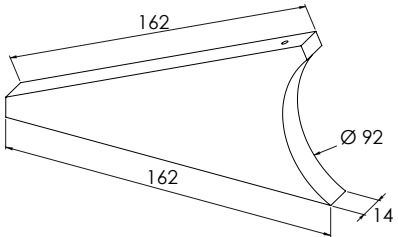
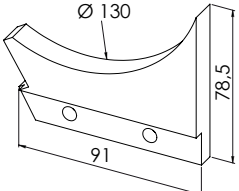
HEIDELBERG GTO NO CPTRONIC		HEIDELBERG GTO CPC + CPTRONIC		HEIDELBERG GTO NO CPTRONIC	
					
<b>9502</b>	RIGHT & LEFT DESTRO e SINISTRO	<b>9619</b>	RIGHT & LEFT DESTRO e SINISTRO	<b>9635</b>	RIGHT & LEFT DESTRO e SINISTRO
HEIDELBERG MO		HEIDELBERG MO CPC		HEIDELBERG SPEEDMASTER 52 CPC + CPTRONIC	
					
<b>9574</b>	RIGHT & LEFT DESTRO e SINISTRO	<b>9503</b>	RIGHT & LEFT DESTRO e SINISTRO	<b>9509</b>	RIGHT & LEFT DESTRO e SINISTRO
HEIDELBERG SPEEDMASTER 52 NO CPC		HEIDELBERG SPEEDMASTER 74		HEIDELBERG SPEEDMASTER 74 CD	
					
<b>9636</b>	RIGHT & LEFT DESTRO e SINISTRO	<b>9504</b>	RIGHT & LEFT DESTRO e SINISTRO	<b>9637</b>	RIGHT & LEFT DESTRO e SINISTRO
HEIDELBERG SPEEDMASTER 72 / 102		HEIDELBERG SPEEDMASTER 72 CD / 102 CD		HEIDELBERG WEB 8/16	
					
<b>9505</b>	RIGHT & LEFT DESTRO e SINISTRO	<b>9515</b>	RIGHT & LEFT DESTRO e SINISTRO	<b>9572</b>	RIGHT & LEFT DESTRO e SINISTRO

## INK DUCT END BLOCKS

## SPALLE DEL CALAMAIO

ROLAND 200 (BAKELITE)		ROLAND 700	
<b>9585</b>	RIGHT & LEFT DESTRO e SINISTRO	<b>9746</b>	RIGHT & LEFT DESTRO e SINISTRO
TISON (CAST IRON / GHISA)		AURELIA 700 (BRONZE / BRONZO)	
<b>9576</b>	RIGHT & LEFT DESTRO e SINISTRO	<b>9587</b>	RIGHT & LEFT DESTRO e SINISTRO

## SCRAPER

## RASCHIETTI

	Ref. Codice	Model Descrizione	Pieces per box Conf. da	Price for Prezzo per	€
	<b>9540</b>	SCRAPER HOLDER FOR INK DUCT BLOCKS PREMIRASCHIETTO PER SPALLE CALAMAI	2	BOX CONF.	
	<b>8001</b>	SCRAPER CLEANER FOR DUCT ROLLER HEIDELBERG RASCHIETTO PER RULLI CALAMAI HEIDELBERG	50	BOX CONF.	
	<b>8002</b>	SCRAPER CLEANER FOR DUCT ROLLER HEIDELBERG WEB RASCHIETTO PER RULLI CALAMAI HEIDELBERG WEB	50	BOX CONF.	
	<b>8013</b>	SCRAPER CLEANER FOR DUCT ROLLER HEIDELBERG WEB RASCHIETTO PER RULLI CALAMAI HEIDELBERG WEB	50	BOX CONF.	
	<b>8014</b>	SCRAPER CLEANER FOR DUCT ROLLER SM 102CD / 105XL RASCHIETTO PER RULLI CALAMAI SM 102CD / 105XL	50	BOX CONF.	

## INK FOUNTAIN BLADES WITH SEGMENTS

## LAME DEL CALAMAIO A SETTORI

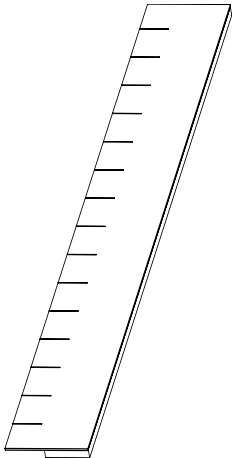
	Ref. Codice	Model Descrizione	Size Dimensioni	€
	<b>9546</b>	HEIDELBERG GTO 46	452 x 86 mm	
<b>9552</b>	HEIDELBERG GTO 52	512 x 94 mm		
<b>9566</b>	HEIDELBERG KOR 57	580 x 100 mm		
<b>9560</b>	HEIDELBERG MO 65	662 x 129,5 mm		
<b>9557</b>	HEIDELBERG SORM 72	730 x 175 mm		
<b>9173</b>	HEIDELBERG SPEEDMASTER 52 (no CPC)	520 x 100 mm		
<b>9156</b>	HEIDELBERG SPEEDMASTER 74	747 x 135 mm		
<b>9558</b>	HEIDELBERG SPEEDMASTER 102	1.030 x 175 mm		
<b>9164</b>	ROLAND PRACTICA 00	510 x 125 mm		
<b>9162</b>	ROLAND 200	730 x 145 mm		
<b>9559</b>	ROLAND	1.030 x 143 mm		
<b>9568</b>	M.A.N. GS 140	1.430 x 152 mm		
<b>9577</b>	LITHOMAN 48	1.502 x 150 mm		
<b>9579</b>	SAKURAI OLIVER 72	746 x 114 mm		
<b>9583</b>	SAKURAI OLIVER 252 RP	596 x 112 mm		
<b>9152</b>	KOMORI SPRINT 28	734 x 106 mm		

## INK FOUNTAIN BLADES

## LAME DEL CALAMAIO

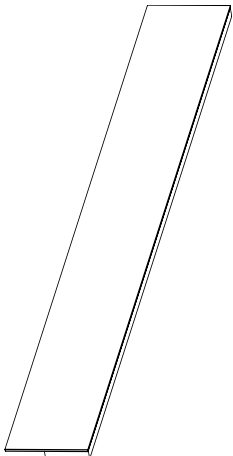
	Ref. Codice	Model Descrizione	Size Dimensioni	€
	<b>9581</b>	HEIDELBERG PLATEN T - STELLA T	375 x 101,5 mm	
<b>9547</b>	HEIDELBERG GTO 46	452 x 86 mm		
<b>9553</b>	HEIDELBERG GTO 52	512 x 94 mm		
<b>9561</b>	HEIDELBERG MO 65	662 x 129,5 mm		
<b>9176</b>	HEIDELBERG KOR 57	580 x 100 mm		
<b>9555</b>	HEIDELBERG KORD 64	670 x 102 mm		
<b>9556</b>	HEIDELBERG KORS 72	740 x 103 mm		
<b>9548</b>	HEIDELBERG SORM 72	730 x 175 mm		
<b>9584</b>	HEIDELBERG SORM 72	730 x 120 mm		
<b>9168</b>	HEIDELBERG SPEEDMASTER 74	747 x 135 mm		
<b>9562</b>	HEIDELBERG SPEEDMASTER 102	1.030 x 175 mm		
<b>9563</b>	ROLAND PRACTICA 00	510 x 125 mm		
<b>9564</b>	ROLAND PRACTICA 01	661 x 125 mm		
<b>9565</b>	ROLAND 200	730 x 145 mm		
<b>9165</b>	ROLAND FAVORIT RF-OB	730 x 110 mm		
<b>9163</b>	ROLAND RZK	1.030 x 110 mm		
<b>9569</b>	ROLAND	1.030 x 143 mm		
<b>9575</b>	M.A.N. GS 140	1.502 x 152 mm		
<b>9578</b>	LITHOMAN 48	1.430 x 150 mm		
<b>9554</b>	FUJI 50	530 x 85 mm		
<b>9582</b>	FUJI 52	530 x 98 mm		
<b>9153</b>	KOMORI SPRINT 28	734 x 106 mm		
<b>9172</b>	KOMORI LITHRONE 40	1.085 x 176 mm		

Ink blades on measure on request.

A richiesta lame del calamaio su misura.

## INK DUCT FOILS

## COPRICALAMAI

Ref. Codice	Model Descrizione	Size Dimensioni	Thickness Spessore	Foils Fogli	€
<b>9706</b>	QUICKMASTER	358 x 200 mm	190 µm	100	
<b>9705</b>	GTO 52 / SPEEDMASTER 52	547 x 200 mm	190 µm	100	
<b>9720</b>	GTO 52 CD / SPEEDMASTER 52 CD	547 x 196 mm	190 µm	100	
<b>9702</b>	SPEEDMASTER 72/74 - SORM	775 x 232 mm	190 µm	100	
<b>9721</b>	SPEEDMASTER 72/74 CD	775 x 228 mm	190 µm	100	
<b>9701</b>	SPEEDMASTER 102	1.067 x 232 mm	190 µm	100	
<b>9723</b>	SPEEDMASTER 102 CD	1.067 x 228 mm	190 µm	100	
<b>9722</b>	SPEEDMASTER 102 CD	1.067 x 228 mm	250 µm	100	
<b>9704</b>	MO	677 x 200 mm	190 µm	100	
<b>9703</b>	SO	935 x 232 mm	190 µm	100	
<b>9707</b>	WEB 8	548 x 260 mm	190 µm	50	
<b>9708</b>	WEB 16 / H 600	1.002 x 260 mm	190 µm	50	
<b>9709</b>	M 110 C	740 x 260 mm	190 µm	50	
<b>9711</b>	ALL 72/74	775 x 232 mm	190 µm	50	
<b>9710</b>	ALL 102	1.067 x 232 mm	190 µm	50	

## INK DUCT TAPES

## BIADESIVI PER CALAMAI

Ref. Codice	Model Descrizione	€
<b>9719</b>	SCOTCH TAPE FOR INK DUCT END BLOCKS - 15 mm x 25 m SCOTCH BIADESIVO PER SPALLE CALAMAIO - 15 mm x 25 m	
<b>9712</b>	BI-ADHESIVE PROTECTIVE FOIL - 70 mm x 25 m ROTOLO BIADESIVO A 2 BANDE PER CALAMI CON CPC - 70 mm x 25m	
<b>9713</b>	SELF-ADHESIVE FOAM - 10 m SCHIUMA AUTOADESIVA - 10 m	
<b>9700</b>	BI-ADHESIVE STRIP FOR INK DUCT END BLOCKS - 15x150 mm (PRICE FOR BOX 10 PIECES) STRISCE BIADESIVE PER SPALLE CALAMAIO - 15x150 mm (PREZZO PER CONFEZIONE DA 10 PEZZI)	

## CYLINDER WASHING BAR FOR MITSUBISHI

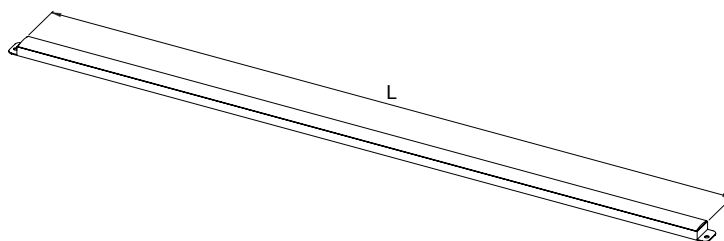

## BARRE LAVACILINDRO MITSUBISHI



Ref. Codice	Description Descrizione	Measure (L) Misura (L)	€
<b>4502</b>	PRESSURE CYLINDER WASHING BAR BARRA LAVACILINDRO	750 mm	
<b>4501</b>	PRESSURE CYLINDER WASHING BAR BARRA LAVACILINDRO	1.050 mm	
<b>4504</b>	PRESSURE CYLINDER WASHING BAR BARRA LAVACILINDRO	1.087 mm	
<b>4500</b>	PRESSURE CYLINDER WASHING BAR BARRA LAVACILINDRO	1.320 mm	
<b>4503</b>	PRESSURE CYLINDER WASHING BAR BARRA LAVACILINDRO	1.470 mm	

# PARTS FOR HEIDELBERG GTO

# RICAMBI PER GTO

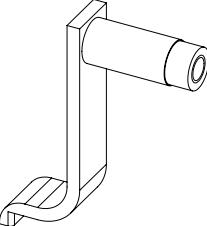
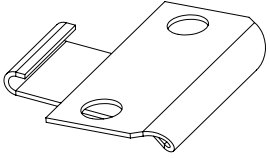
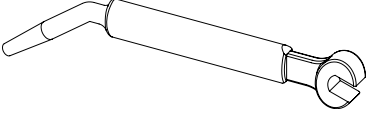
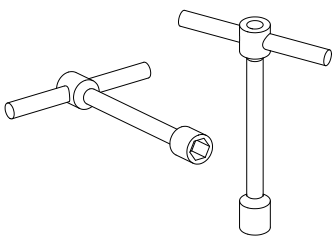
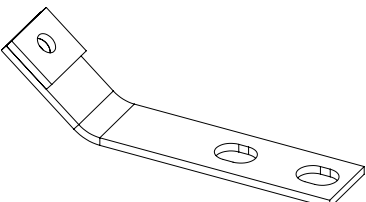
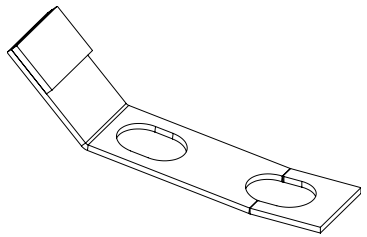
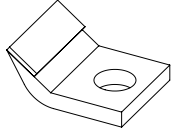
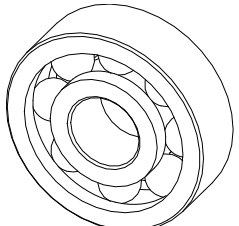
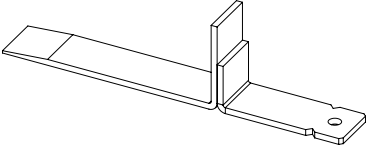
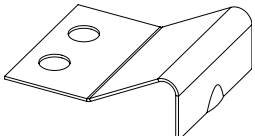
SPEED CLAMPS KIT		BLANKET BAR KIT		FRONT GUIDE	
KIT BARRE CHIUSURA RAPIDA		KIT BARRE CAUCCIU'		REGISTRO	
					
<b>4551</b>	GTO 46	<b>69.006.002F</b>			
<b>4553</b>	GTO 46 MULTICOLOR	<b>9526</b>	GTO 46	<b>9533</b>	46 & 52 - each piece
<b>4552</b>	GTO 52	<b>9527</b>	GTO 52		46 e 52 - ogni pezzo
BLANKET BAR LOCK GTO		PLATE SPANNER (11 mm)		SPANNERS T-HANDLE	
GANCIO BARRA CAUCCIU' GTO		CHIAVE 11 mm CON PERNO		CHIAVI A "T"	
					
<b>42.006.033F</b>					
<b>9639</b>	each piece ogni pezzo	<b>9573</b>	46 & 52 - each piece 46 e 52 - ogni pezzo	<b>9588</b>	L: 115 mm - $\square$ : 10 mm
				<b>9589</b>	L: 285 mm - $\square$ : 17 mm
FEEDER GRIPPER		DELIVERY GRIPPER GTO / "K"-SERIES		CYLINDER GRIPPER	
PINZA METTIFOGLIO		PINZA USCITA GTO / SERIE "K"		PINZA CILINDRO	
					
<b>43.020.035</b>		<b>14.875.001 F</b>		<b>69.011.727</b>	
<b>9521</b>	box 2 - each piece conf. 2 pz - ogni pezzo	<b>9522</b>	box 10 - each piece conf. 10 pz - ogni pezzo	<b>9510</b>	46 & 52 - each piece 46 e 52 - ogni pezzo
BEARING FOR GTO / MO		HOLD DOWN STRAP		SPRING CLIP FOR HOLD DOWN STRAPS	
CUSCINETTI PER GTO / MO		GUIDA FERMA-FOGLI USCITA		MOLLA PER GUIDA FERMA-FOGLI	
					
		<b>42.015.240</b>		<b>42.015.241</b>	
<b>9050</b>	$\varnothing$ 28 x 8 x $\varnothing$ 12 mm	<b>9523</b>	46 & 52 - each piece	<b>9524</b>	46 & 52 - each piece
<b>9051</b>	$\varnothing$ 25 x 8 x $\varnothing$ 10 mm		46 e 52 - ogni pezzo		46 e 52 - ogni pezzo

# PARTS FOR HEIDELBERG GTO

# RICAMBI PER GTO

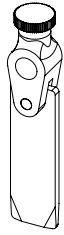
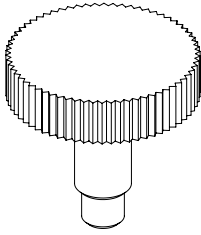
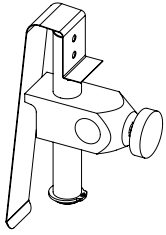
SHEET HOLDER		KNURLED SCREW		EXTENDED SHEET HOLDER	
FERMA FOGLIO COMPLETO		VITE ZIGRINATA		FERMA FOGLIO	
					
				<b>T 2214 F</b>	
<b>9687</b>	each piece ogni pezzo	<b>9688</b>	each piece ogni pezzo	<b>9689</b>	box 2 - each box conf. 2 pz - ogni confezione

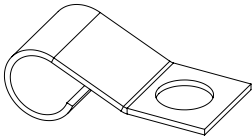
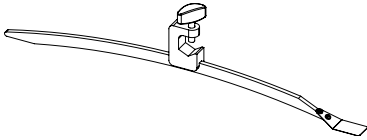
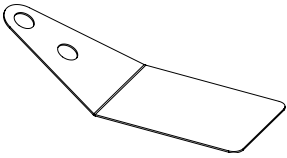
INK DUCT END BLOCK SPRING		COMPLETE SHEET SMOOTHER		SPRING PLATE FOR SHEET SMOOTHERS	
MOLLETTA PER SPALLE CALAMAIO		GUIDA-FOGLIO COMPLETO		GUIDA FOGLIO	
					
<b>9648</b>	box 2 - each piece conf. 2 pz - ogni pezzo	<b>9622</b>	GTO 46	<b>9507</b>	box 10 - each piece conf. 10 pz - ogni pezzo
		<b>9624</b>	GTO 52		

GEAR GTO	
PERNO GTO	
	
<b>MV.019.823</b>	
<b>9755</b>	each piece ogni pezzo

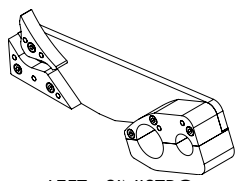
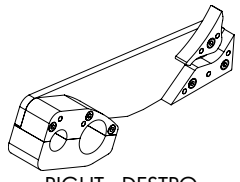
 LEFT - SINISTRO		NUMBERING CAMS / CAMME COMANDO NUMERATORI		
		Ref. Codice	Model Descrizione	€
 RIGHT - DESTRO		<b>9640</b>	GTO 52 RIGHT / DESTRO	
		<b>9641</b>	GTO 52 LEFT / SINISTRO	
		<b>9642</b>	GTO 52 DOUBLE RIGHT / DOPPIO DESTRO	
		<b>9643</b>	GTO 52 DOUBLE LEFT / DOPPIO SINISTRO	
		<b>9644</b>	GTO 46 RIGHT / DESTRO	
		<b>9645</b>	GTO 46 LEFT / SINISTRO	
		<b>9646</b>	GTO 46 DOUBLE RIGHT / DOPPIO DESTRO	
		<b>9647</b>	GTO 46 DOUBLE LEFT / DOPPIO SINISTRO	

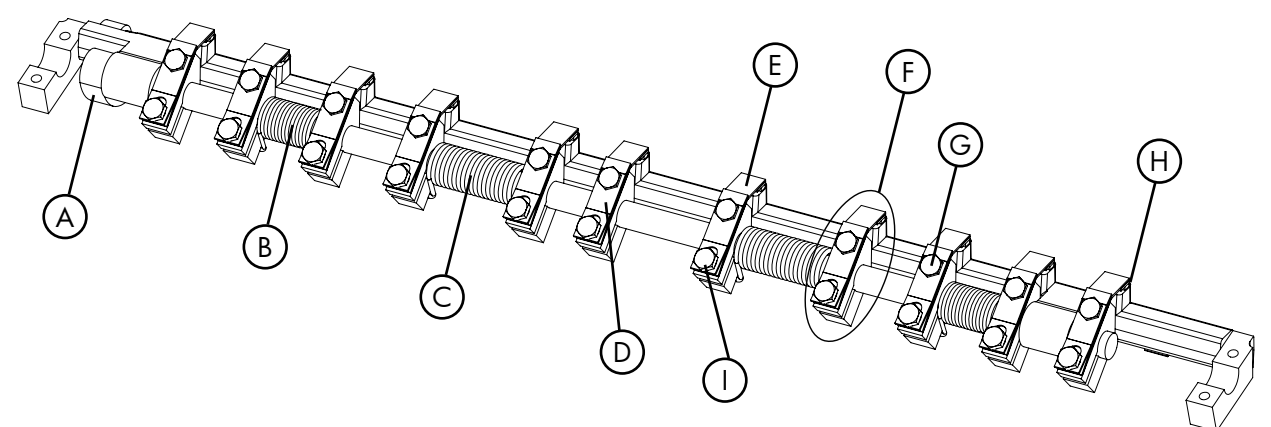
DELIVERY BARS / BARRE DI USCITA					
					
	Ref. Codice	Heidelberg number (GTO 52)	Model Descrizione		€
-	<b>9570</b>		COMPLETE BAR GTO 46	BARRA COMPLETA GTO 46	
-	<b>9571</b>	69.014.003 F	COMPLETE BAR GTO 52	BARRA COMPLETA GTO 52	
<b>A</b>	<b>9651</b>	42.014.007 42.014.008 00.550.0251	COMPLETE CAM LEVER	CAMMA COMPLETA	
<b>B</b>	<b>9652</b>	-	SMALL TORSIONS SPRING	MOLLA DI TORSIONE PICCOLA	
<b>C</b>	<b>9653</b>	04.014.009	BIG TORSIONS SPRING	MOLLA DI TORSIONE GRANDE	
<b>D</b>	<b>9654</b>	14.014.041	GRIPPER BACKING PLATE	PIASTRINA FERMA PINZA	
<b>E</b>	<b>9522</b>	14.875.001 F	GRIPPER	PINZA	
<b>F</b>	<b>9529</b>	03.014.005 14.875.001 F 14.014.043 14.014.041	COMPLETE GRIPPER HOLDER	PINZA USCITA COMPLETA	
<b>G</b>	<b>9655</b>	14.014.043	HEXAGON-HEAD SCREW	VITE TESTA ESAGONALE	
<b>H</b>	<b>9656</b>	-	SMALL RASP	LIMETTA	
<b>I</b>	<b>9658</b>	-	M6 x 20 SCREW	VITE M6 x 20	



# PARTS FOR HEIDELBERG S-SERIES PARTI PER TIPOGRAFICHE HEIDELBERG

CARRIAGE GRIPPER FEED FINGER		GRIPPER FOR DELIVERY CHAIN		DELIVERY CARRIAGE GRIPPER FINGER	
PINZETTA METTIFOGLIO		PINZETTA CATENA USCITA		PINZETTA CARRO USCITA	
				<b>S 1451 F</b>	
<b>9543</b>	box 4 - each piece conf. 4 pz - ogni pezzo	<b>9544</b>	box 10 - each piece conf. 10 pz - ogni pezzo	<b>9545</b>	box 10 - each piece conf. 10 pz - ogni pezzo
COVER PLATE FOR FEEDER GRIPPER		COVER PLATE FOR DELIVERY CHAIN GRIPPER		COVER PLATE FOR CARRIAGE GRIPPER	
PIASTRINA RETRO PINZA METTIFOGLIO		PIASTRINA RETRO PINZA CATENA USCITA		PIASTRINA RETRO PINZA CARRO	
				<b>S 14119</b>	
<b>9697</b>	box 4 - each piece conf. 4 pz - ogni pezzo	<b>9654</b>	box 10 - each piece conf. 10 pz - ogni pezzo	<b>9698</b>	box 10 - each piece conf. 10 pz - ogni pezzo
CYLINDER GRIPPER HEIDELBERG TYPO		SILICONE SHEET STOP HBG TYPO			
PINZA CILINDRO TIPOGRAFICHE HBG		FERMAFOGLI SILICONE TIPOGRAFICHE			
<b>9525</b>	box 10 - each piece conf. 10 pz - ogni pezzo	<b>9616</b>	box 10 - each piece conf. 10 pz - ogni pezzo		

# PARTS FOR HEIDELBERG PLATEN

# PARTI PER STELLA HEIDELBERG

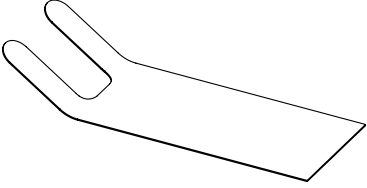
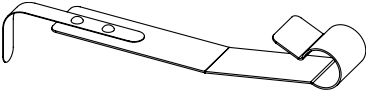
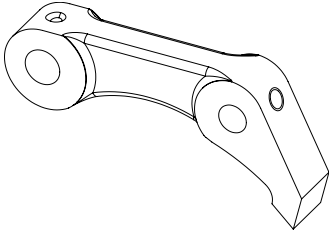
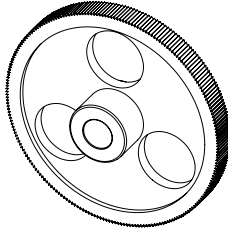
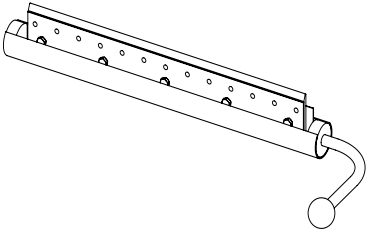
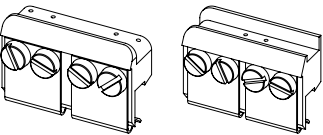
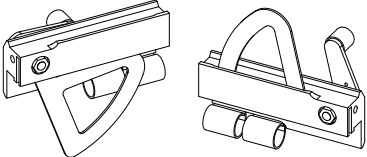
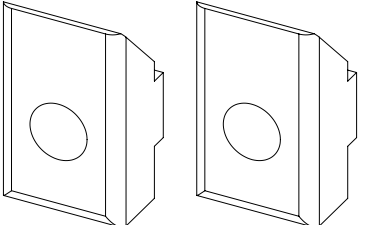
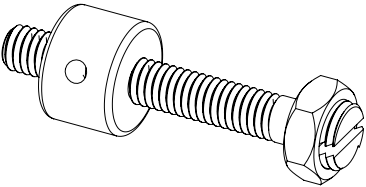
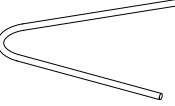
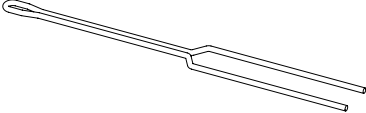
WINDMILL GRIPPER ARM		WINDMILL TRIPPING SPRING		WINDMILL SHEET SEPARATOR SPRING	
PINZA STELLA		MOLLA CENTRALE STELLA		MOLLA LATERALE STELLA	
					
T 1304 F		T 1203		T 1249 F	
<b>9500</b>	T - 26x38 (10"x15")	<b>9518</b>	box 5 - each piece conf. 5 pz - ogni pezzo	<b>9520</b>	box 10 - each piece conf. 10 pz - ogni pezzo
<b>9501</b>	GT - 32x46 (13"x18")				
HOOK UP PILE		RATCHET WHEEL		COMPLETE WASH-UP BLADE TRAY	
GANCIO ALZAPILA		RUOTA DENTATA ALZAPILA		VASCHETTA PORTA LAMA LAVARULLI	
					
T 1103		T 1101			
<b>9541</b>	T & GT - each piece T e GT - ogni pezzo	<b>9609</b>	T & GT - each piece T e GT - ogni pezzo	<b>9121</b>	each piece ogni pezzo
BRASS GUIDER		AUTOMATIC GUIDER		LUGS FOR HOLDING CHASE	
SQUADRETTA OTTONE		SQUADRETTA AUTOMATICA		BLOCCHETTI FERMA TELAIO	
					
T 0265 F / T 0264 F				T0104R / T0104L	
<b>9120</b>	RIGHT & LEFT DESTRA e SINISTRA	<b>6225</b>	RIGHT & LEFT DESTRA e SINISTRA	<b>9760</b>	RIGHT & LEFT DESTRA e SINISTRA
ADJUSTING SCREW WITH COLLAR AND NUT		OPEN PINS		PINS (box 10 - price for box)	
VITE DI REGOLAZIONE CON ANELLO E DADO		SPILLI DIVARICATI		SPILLI (conf. 10 pz - prezzo per conf.)	
					
T 0237 / T 0269		T 0244		T 0246	
<b>9770</b>	each kit ogni set	<b>9138</b>	box 10 - price for box conf. 10 pz - prezzo per conf.	<b>9130</b>	A - L = 37 mm
				<b>9132</b>	B - L = 45 mm
				<b>9134</b>	C - L = 56 mm
				<b>9136</b>	D - L = 68 mm
				<b>9139</b>	E - L = 75 mm

# PARTS FOR HEIDELBERG PLATEN

# PARTI PER STELLA HEIDELBERG

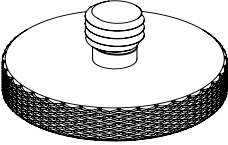
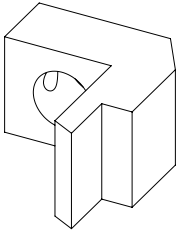
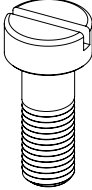
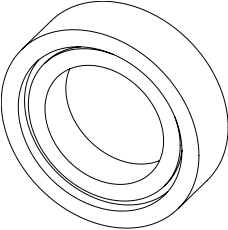
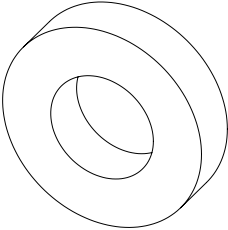
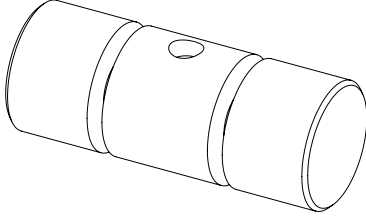
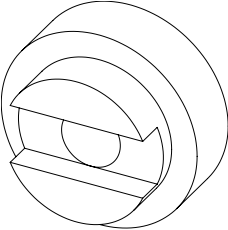
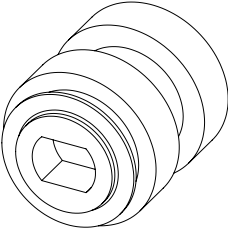
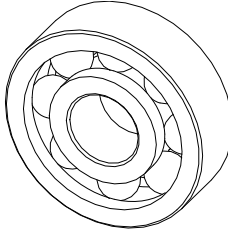
ADJUSTING SCREW		SIDE LAY GAUGE		CHEESE-HEADED SCREW	
VITE REGOLAZIONE SQUADRA		SQUADRA LATERALE		VITE A TAGLIO TESTA CILINDRICA	
					
T 0217		T 0220		T 0229	
<b>9753</b>	each piece ogni pezzo	<b>9754</b>	each piece ogni pezzo	<b>9752</b>	each piece ogni pezzo
SHEAR COLLAR PLATEN T		PRESSURE RING PLATEN T		SHEAR BOLT PLATEN GT	
ANELLO DI SICUREZZA STELLA T		ANELLO DI PRESSIONE STELLA T		ALBERO PRESSIONE STELLA GT	
					
T 0152		T 0153		GT 1724	
<b>9140</b>	each piece ogni pezzo	<b>9141</b>	each piece ogni pezzo	<b>9142</b>	each piece ogni pezzo
BLACK ROLL FOR T ROLLERS		BLACK PLASTIC ROLL FOR GT ROLLERS		BEARING FOR ROLLERS	
ROTELLA PER RULLI STELLA T		ROTELLA PLASTICA PER RULLI GT		CUSCINETTO PER RULLI	
					
T 0911		GT 0912		J 5	
<b>9126</b>	box 4 - each piece conf. 4 pz - ogni pezzo	<b>9127</b>	box 4 - each piece conf. 4 pz - ogni pezzo	<b>9125</b>	T - Ø 26 x 8 x Ø 9,5 mm
				<b>9124</b>	GT - Ø 28 x 8 x Ø 12 mm

## SPARE PARTS FOR FEEDER

## PARTI PER METTIFOGLIO

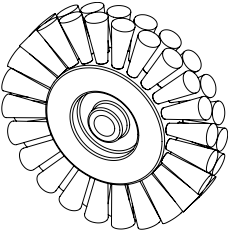
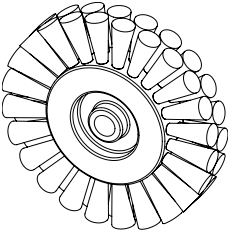
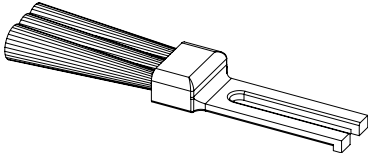
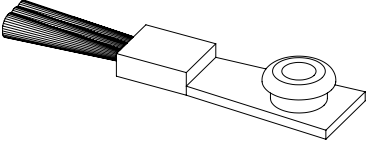
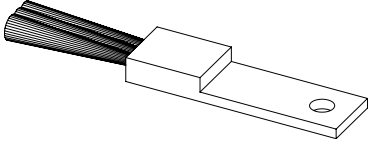
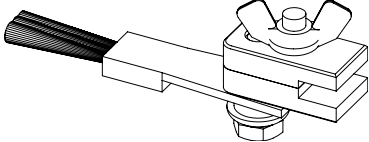
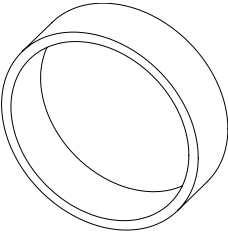
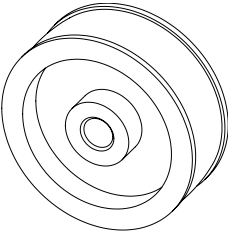
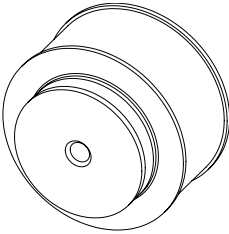
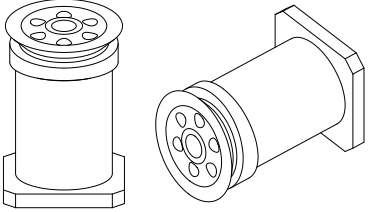
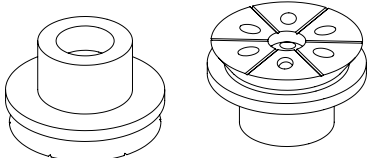

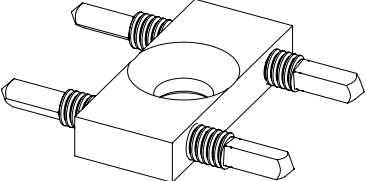
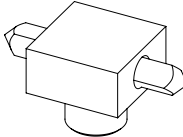
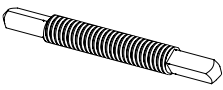

WHITE BRUSH WHEEL (soft - paper)		BLACK BRUSH WHEEL (hard - cardboard)		SHEET SEPARATING BRUSH - WHITE	
SPAZZOLA TONDA MORBIDA BIANCA		SPAZZOLA TONDA DURA NERA		SPAZZOLINA SEPARAFOGLI BIANCA	
					
<b>9610</b>	Ø 60 x 12 x Ø 6 mm each piece - ogni pezzo	<b>9612</b>	Ø 60 x 12 x Ø 6 mm each piece - ogni pezzo	<b>9600</b>	box 10 - each piece conf. 10 pz - ogni pezzo
SHEET SEPARATING BRUSH - BLACK		SHEET SEPARATING BRUSH - BLACK		BRUSH FOR GTO WITH CLAMP	
SPAZZOLINA SEPARAFOGLI BLACK		SPAZZOLINA SEPARAFOGLI BLACK		SPAZZOLINA PER GTO CON MORSETTO	
					
<b>9602</b>	box 10 - each piece conf. 10 pz - ogni pezzo	<b>9608</b>	box 10 - each piece conf. 10 pz - ogni pezzo	<b>9551</b>	each piece ogni pezzo
RUBBER RINGS FOR MABEG		ROLL FOR MABEG - 40x14 mm		ROLL FOR MABEG	
ANELLI IN GOMMA PER MABEG		ROTELLA PER MABEG - 40x14 mm		ROTELLA PER MABEG	
					
<b>9537</b>	Ø 38 x 12 mm	<b>9629</b>	HOLE / FORO Ø 6 mm	<b>9539</b>	Ø 54 x 27 x Ø 6 mm each piece - ogni pezzo
<b>9538</b>	Ø 50 x 25 mm	<b>9632</b>	HOLE / FORO Ø 10 mm		
SUCKER HOLDER FOR SM 102 - MO - SORM/D/S		SUCKER HOLDER FOR MABEG			
PORTAVENTOSA SM 102 - MO - SORM/D/S		PORTAVENTOSA PER MABEG			
					
<b>9657</b>	each piece ogni pezzo	<b>9675</b>	each piece ogni pezzo		

# PARTS FOR HOT STAMPING

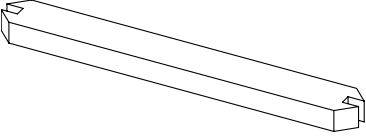
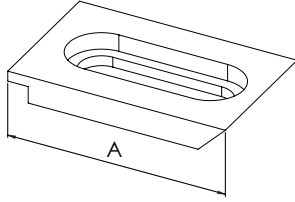
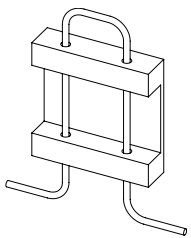
# PARTI PER STAMPA A CALDO

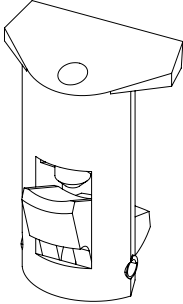
DOUBLE CLAMPING DOG		SINGLE CLAMPING DOG		SCREW FOR CLAMPING DOG	
MORSETTO COMPLETO PER CLICHE'		MORSETTO SINGOLO PER CLICHE'		VITI PER MORSETTO CLICHE'	
					
GTP 56131F		GTP 56133F			
<b>9530</b>	each piece	<b>9744</b>	each piece	<b>9531</b>	L: 36 mm (for/per 9530)
	ogni pezzo		ogni pezzo	<b>9743</b>	L: 20 mm (for/per 9744)

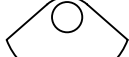
KEY FOR CLAMP FOR BLOCKS		CLAMP FOR BLOCKS		GUIDER FOR CREASING	
CHIAVE PER MORSETTO CLICHE'		STAFFA PER CLICHE'		SQUADRETTA A NASTRO	
					
<b>9532</b>	each piece	<b>9542</b>	A = 32 mm	<b>9634</b>	each piece
	ogni pezzo	<b>9761</b>	A = 64 mm		ogni pezzo

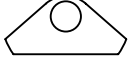
TOGGLE HOOKS / MORSETTI					
		0 - Narrow margin hook 0 - Morsetto con margine ridotto		3E - Extended jaw register hook 3E - Morsetto con dente esteso	
		1 - Standard register hook 1 - Morsetto standard		4 - Extra-extended jaw register hook 4 - Morsetto con dente extra-esteso	
		2 - Register hook with slightly larger jaw 2 - Morsetto con dente maggiorato			

STANDARD			PREMIUM			LOW PROFILE / RIBASSATI		
Ref. Codice	Hook size Misura	€	Ref. Codice	Hook size Misura	€	Ref. Codice	Hook size Misura	€
<b>8020</b>	1		<b>8030</b>	0		<b>8035</b>	1	
<b>8021</b>	2		<b>8031</b>	1		<b>8036</b>	2	
<b>8022</b>	3E		<b>8032</b>	2		<b>8037</b>	3E	
<b>8023</b>	4		<b>8033</b>	3		<b>8038</b>	4	
			<b>8034</b>	4				

Ref. Codice	Description Descrizione	€
<b>8026</b>	TOGGLE BIT PART	RICAMBIO QUADRATO CHIAVE
<b>8027</b>	TOGGLE KEY COMPLETE	CHIAVE PER CHIUSURA MORSETTI
<b>8028</b>	TOGGLE KEY DRIVER PART	CACCIAVITE PER SOSTITUZIONE CHIAVETTA

# PARTS FOR CUTTING/CREASING RICAMBI PER TAGLIO/CORDONATURA

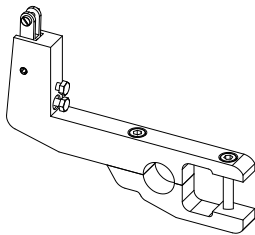
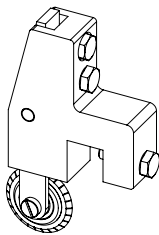
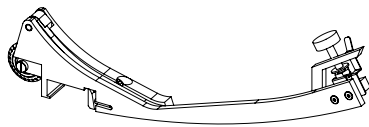
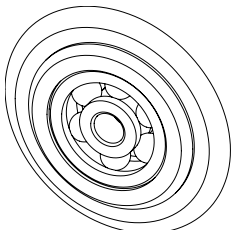
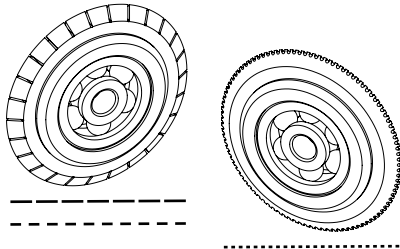
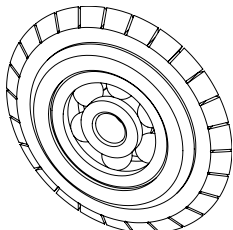
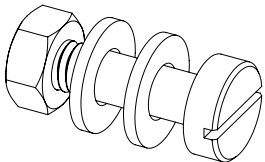
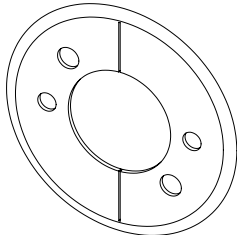
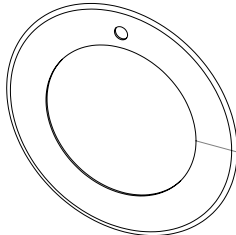
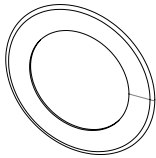
PERFORATING ARM GTO 52		PERFORATING ARM GTO 52 - II COLOR		PERFORATING ARM SM 52	
SUPPORTO PERFORATORE GTO 52		SUPPORTO PERF. GTO 52 - 2° COLORE		SUPPORTO PERFORATORE SM 52	
 <p>Wheel not included / ruota non inclusa</p>		 <p>Wheel not included / ruota non inclusa</p>		 <p>Wheel not included / ruota non inclusa</p>	
<b>9631</b>	each piece ogni pezzo	<b>9693</b>	each piece ogni pezzo	<b>9638</b>	each piece ogni pezzo
WHEEL FOR GTO & SM (Ø30 x Ø4)		WHEEL FOR GTO & SM (Ø30 x Ø4)		WHEEL FOR ROLAND PRACTICA	
ROTELLE PER GTO & SM (Ø30 x Ø4)		ROTELLE PER GTO & SM (Ø30 x Ø4)		ROTELLE PER ROLAND PRACTICA	
					
<b>9041</b>	CREASING / CORDONAT.	<b>9043</b>	26 TEETH - 26 DENTI	<b>9046</b>	Ø30 x Ø4 - 24 TEETH/DENTI
<b>9042</b>	CUT / TAGLIO	<b>9045</b>	39 TEETH - 39 DENTI	<b>9047</b>	Ø48 x Ø4 - 40 TEETH/DENTI
<b>9044</b>		<b>9044</b>	MICRO		
COMPLETE SCREW FOR PERF. WHEEL					
VITE COMPLETA PER ROTELLA					
					
<b>9771</b>	each piece ogni pezzo				
HORIZON CUTTING WHEEL		STAHLFOLDER 78 CUTTING WHEEL		STAHLFOLDER 36 CUTTING WHEEL	
ROTELLA TAGLIO HORIZON		ROTELLA TAGLIO STAHLFOLDER 78		ROTELLA TAGLIO STAHLFOLDER 36	
					
<b>9690</b>	Ø 54 x 1 x Ø 24 mm Ø 54 x 1 x Ø 24 mm	<b>9691</b>	Ø 61,5 x 0,5 x Ø 40 mm Ø 61,5 x 0,5 x Ø 40 mm	<b>9692</b>	Ø 39 x 0,5 x Ø 26 mm Ø 39 x 0,5 x Ø 26 mm

# BOBST SPARE PARTS

# PARTI DI RICAMBIO PER BOBST

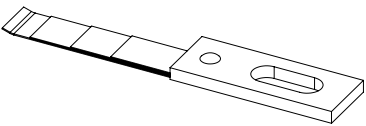
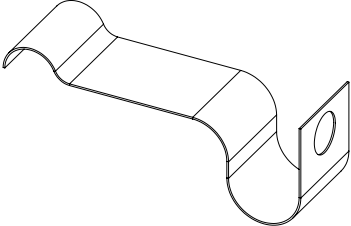
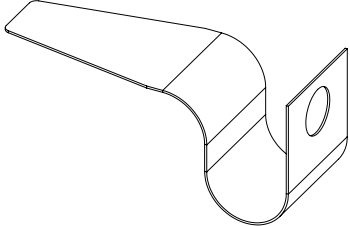
SHEET SEPARATOR		SHEET SEPARATOR		SHEET SEPARATOR	
SEPARAFOGLI CON SUPPORTO		SEPARAFOGLI		SEPARAFOGLI	
					
BOBST #: 581 2124		BOBST #: BSA 0306 1247 00 EX		BOBST #: EX 0694 1871 00	
<b>9730</b>	each piece ogni pezzo	<b>9731</b>	thickness: 0,3 mm	<b>9733</b>	thickness: 0,3 mm
		<b>9732</b>	thickness: 0,5 mm	<b>9734</b>	thickness: 0,5 mm

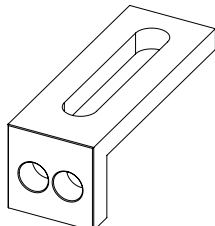
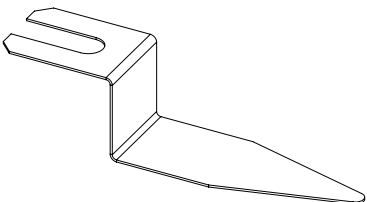
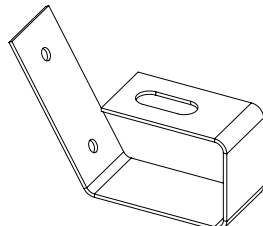
SHEET GUIDER SUPPORT		SHEET GUIDER		BRUSH SUPPORT	
SUPPORTO GUIDAFOGLIO		GUIDAFOGLIO		TELAIO PER SPAZZOLINA	
					
BOBST #:		BOBST #: 644 2486		BOBST #: 581 1879	
<b>9735</b>	each piece ogni pezzo	<b>9738</b>	each piece ogni pezzo	<b>9739</b>	each piece ogni pezzo

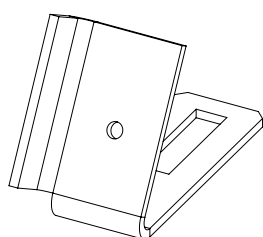
BRUSH SUPPORT	
TELAIO PER SPAZZOLINA	
	
BOBST #: 581 2327	
<b>9740</b>	each piece ogni pezzo

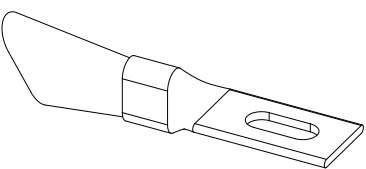
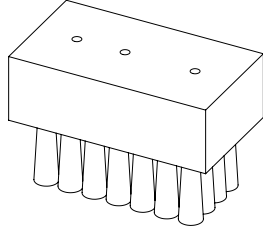
HORSE BRUSH		WOOD AND BRASS BRUSH	
SPAZZOLINA IN RAME		SPAZZOLA LEGNO E OTTONE	
			
BOBST #: EX 0581 1049 00		BOBST #: BSA 1027 0078 100	
<b>9741</b>	each piece ogni pezzo	<b>9742</b>	each piece ogni pezzo

# SHEET SEPARATORS

# SEPARAFOGLI

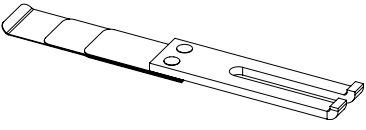
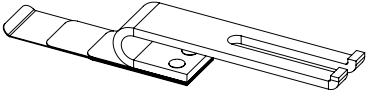
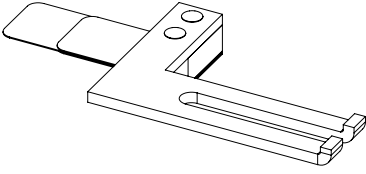
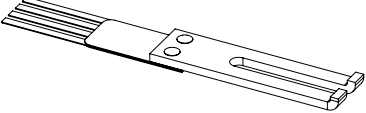
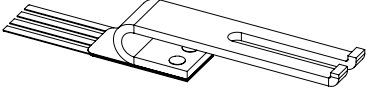
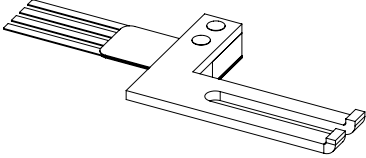
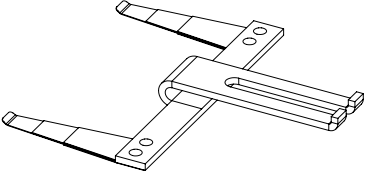
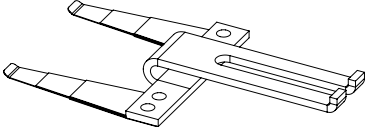
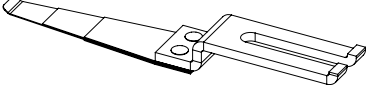
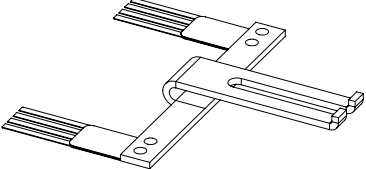
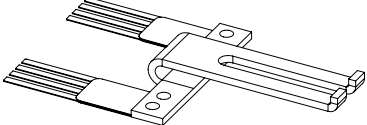
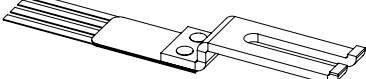
SHEET SEPARATOR SPEEDMASTER		SHEET SEPARATOR SPEEDMASTER		SHEET SEPARATOR SM 72	
SEPARAFOGLIO SPEEDMASTER		SEPARAFOGLIO SPEEDMASTER		SEPARAFOGLIO SM 72	
					
<b>9715</b>	box 10 - each piece conf. 10 pz - ogni pezzo	<b>9716</b>	box 10 - each piece conf. 10 pz - ogni pezzo	<b>9549</b>	RIGHT & LEFT DESTRO e SINISTRO
SHEET SEPARATOR SPEEDMASTER		SHEET SEPARATOR SPEEDMASTER		SHAPED SHEET SEPARATOR SM 72	
SEPARAFOGLIO SPEEDMASTER		SEPARAFOGLIO SPEEDMASTER		SEPARAFOGLIO A PETTINE SM 72	
					
<b>9717</b>	box 10 - each piece conf. 10 pz - ogni pezzo	<b>9718</b>	box 10 - each piece conf. 10 pz - ogni pezzo	<b>9550</b>	RIGHT & LEFT DESTRO e SINISTRO
SHEET SEPARATOR SPEEDMASTER		SHEET SEPARATOR SPEEDMASTER		SHEET SEPARATOR SPEEDMASTER	
SEPARAFOGLIO SPEEDMASTER		SEPARAFOGLIO SPEEDMASTER		SEPARAFOGLIO SPEEDMASTER	
					
<b>9726</b>	each piece ogni pezzo	<b>9728</b>	each piece ogni pezzo	<b>9725</b>	box 2 - each piece conf. 2 pz - ogni pezzo
SHEET SEPARATOR SPEEDMASTER		SHEET SEPARATOR SPEEDMASTER		SHEET SEPARATOR SPEEDMASTER	
SEPARAFOGLIO SPEEDMASTER		SEPARAFOGLIO SPEEDMASTER		SEPARAFOGLIO SPEEDMASTER	
					
<b>9727</b>	each piece ogni pezzo	<b>9729</b>	each piece ogni pezzo	<b>9745</b>	box 2 - each piece conf. 2 pz - ogni pezzo



# SHEET SEPARATORS

# SEPARAFOGLI

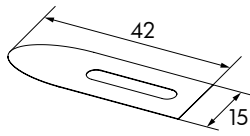
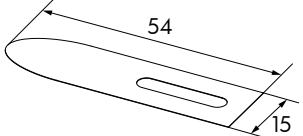
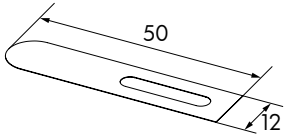
SHEET SEPARATOR 42x15		SHEET SEPARATOR 54x15		SHEET SEPARATOR 50x12	
SEPARAFOGLIO 42x15		SEPARAFOGLIO 54x15		SEPARAFOGLIO 50x12	
					
<b>4210</b>	0,10 mm - 100 pcs/pz	<b>4410</b>	0,10 mm - 100 pcs/pz	<b>4510</b>	0,10 mm - 100 pcs/pz
<b>4220</b>	0,20 mm - 100 pcs/pz	<b>4420</b>	0,20 mm - 100 pcs/pz	<b>4520</b>	0,20 mm - 100 pcs/pz
<b>4230</b>	0,30 mm - 100 pcs/pz	<b>4430</b>	0,30 mm - 100 pcs/pz	<b>4530</b>	0,30 mm - 100 pcs/pz

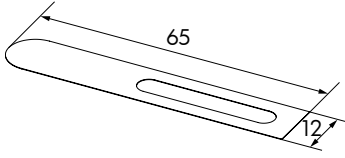
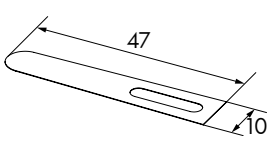
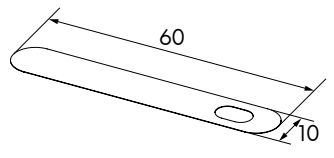
SHEET SEPARATOR 65x12		SHEET SEPARATOR 47x10		SHEET SEPARATOR 60x10	
SEPARAFOGLIO 65x12		SEPARAFOGLIO 47x10		SEPARAFOGLIO 60x10	
					
<b>4610</b>	0,10 mm - 100 pcs/pz	<b>4710</b>	0,10 mm - 100 pcs/pz	<b>4740</b>	0,10 mm - 100 pcs/pz
<b>4620</b>	0,20 mm - 100 pcs/pz	<b>4720</b>	0,20 mm - 100 pcs/pz	<b>4745</b>	0,20 mm - 100 pcs/pz
<b>4630</b>	0,30 mm - 100 pcs/pz	<b>4730</b>	0,30 mm - 100 pcs/pz	<b>4750</b>	0,30 mm - 100 pcs/pz

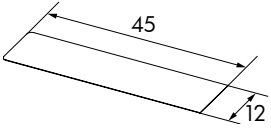
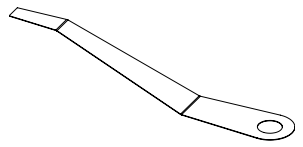
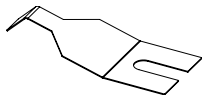
SHEET SEPARATOR 45x12		SHEET SEPARATOR 65x10		SHEET SEPARATOR FOR RYOBI	
SEPARAFOGLIO 45x12		SEPARAFOGLIO 65x10		SEPARAFOGLIO RYOBI	
					
<b>4810</b>	0,10 mm - 100 pcs/pz	<b>4760</b>	0,10 mm - 100 pcs/pz	<b>4209</b>	0,15 mm - 10 pieces
<b>4820</b>	0,20 mm - 100 pcs/pz	<b>4765</b>	0,20 mm - 100 pcs/pz		0,15 mm - 10 pezzi
<b>4830</b>	0,30 mm - 100 pcs/pz	<b>4770</b>	0,30 mm - 100 pcs/pz		

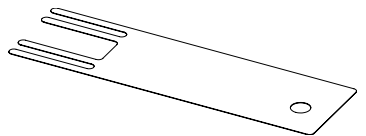
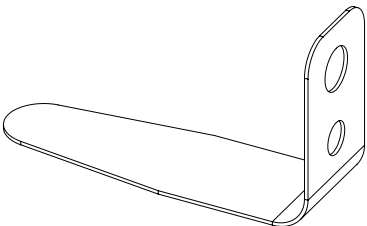
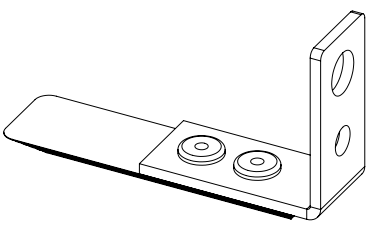
SHEET SEPARATOR FOR HORIZON		SHEET SEPARATOR KBA RAPIDA		SHEET SEPARATOR KBA RAPIDA	
SEPARAFOGLIO HORIZON		SEPARAFOGLIO KBA RAPIDA		SEPARAFOGLIO KBA RAPIDA	
					
<b>9630</b>	0,10 mm - 2 pieces	<b>4733</b>	box 10 - each piece	<b>4731</b>	L = 50 mm
	0,10 mm - 2 pezzi		conf. 10 pz - ogni pezzo	<b>4732</b>	L = 45 mm

# SHEET SEPARATORS

# SEPARAFOGLI

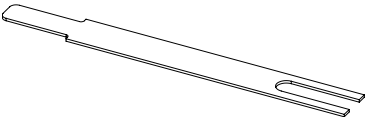
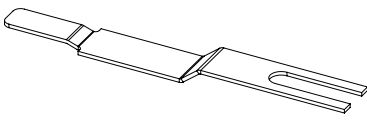
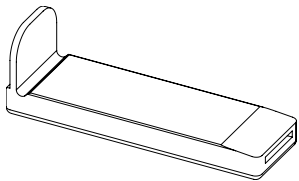
FLAT RUBBER HOLDER		SHAPED RUBBER HOLDER		RUBBER HOOD	
PORTAGOMMINO DRITTO		PORTAGOMMINO PIEGATO		GOMMINO SEPARAFOGLIO	
					
<b>9508</b>	L = 85 mm	<b>9513</b>	L = 95 mm	<b>9516</b>	box 20 - each piece
<b>9512</b>	L = 110 mm	<b>9511</b>	L = 150 mm		conf. 20 pz - ogni pezzo

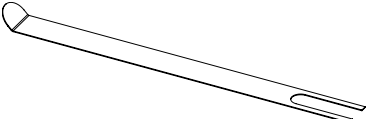
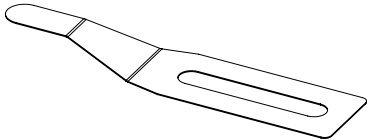
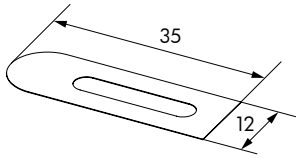
HEIDELBERG SHEET SEPARATOR		MITSUBISHI SHEET SEPARATOR		HAMADA SHEET SEPARATOR	
SEPARAFOGLIO HEIDELBERG		SEPARAFOGLIO PER MITSUBISHI		SEPARAFOGLIO PER HAMADA	
					
<b>9506</b>	L = 120 mm	<b>4110</b>	0,10 mm - 100 pcs/pz	<b>4310</b>	0,10 mm - 100 pcs/pz
<b>9517</b>	L = 145 mm	<b>4111</b>	0,15 mm - 100 pcs/pz	<b>4320</b>	0,20 mm - 100 pcs/pz
<b>9514</b>	L = 170 mm	<b>4112</b>	0,20 mm - 100 pcs/pz	<b>4330</b>	0,30 mm - 100 pcs/pz
		<b>4113</b>	0,30 mm - 100 pcs/pz		

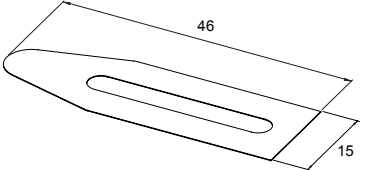
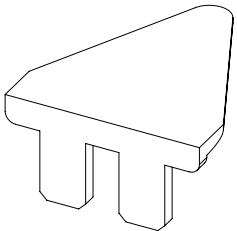
BOBST SHEET SEPARATOR		PLASTIC ROLAND SHEET SEPARATOR	
SEPARAFOGLI PER BOBST		SEPARAFOGLI ROLAND IN PLASTICA	
			
<b>4010</b>	0,10 mm - 100 pcs/pz	<b>4314</b>	each piece
<b>4020</b>	0,20 mm - 100 pcs/pz		ogni pezzo
<b>4030</b>	0,30 mm - 100 pcs/pz		

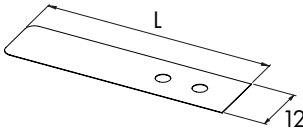
SHEET SEPARATOR - 2 HOLES SEPARAFOGLIO A 2 FORI				SHEET SEPARATOR HEIDELBERG SEPARAFOGLIO HEIDELBERG			
							
				<b>9659</b>	L = 60 mm	THICK/SPESS = 0,10 mm	10 pcs/pz
				<b>9660</b>	L = 60 mm	THICK/SPESS = 0,15 mm	10 pcs/pz
				<b>9661</b>	L = 60 mm	THICK/SPESS = 0,20 mm	10 pcs/pz
				<b>9662</b>	L = 60 mm	THICK/SPESS = 0,30 mm	10 pcs/pz
				<b>9663</b>	L = 90 mm	THICK/SPESS = 0,10 mm	10 pcs/pz
<b>4159</b>	L = 30 mm	THICK/SPESS = 0,1 mm	10 pcs/pz	<b>9664</b>	L = 90 mm	THICK/SPESS = 0,15 mm	10 pcs/pz
<b>4160</b>	L = 35 mm	THICK/SPESS = 0,1 mm	10 pcs/pz	<b>9665</b>	L = 90 mm	THICK/SPESS = 0,20 mm	10 pcs/pz
<b>4161</b>	L = 37 mm	THICK/SPESS = 0,1 mm	10 pcs/pz	<b>9666</b>	L = 90 mm	THICK/SPESS = 0,30 mm	10 pcs/pz
<b>4162</b>	L = 38 mm	THICK/SPESS = 0,1 mm	10 pcs/pz	<b>9667</b>	L = 120 mm	THICK/SPESS = 0,10 mm	10 pcs/pz
<b>4163</b>	L = 39 mm	THICK/SPESS = 0,1 mm	10 pcs/pz	<b>9668</b>	L = 120 mm	THICK/SPESS = 0,15 mm	10 pcs/pz
<b>4164</b>	L = 40 mm	THICK/SPESS = 0,1 mm	10 pcs/pz	<b>9669</b>	L = 120 mm	THICK/SPESS = 0,20 mm	10 pcs/pz
<b>4165</b>	L = 41 mm	THICK/SPESS = 0,1 mm	10 pcs/pz	<b>9670</b>	L = 120 mm	THICK/SPESS = 0,30 mm	10 pcs/pz
<b>4166</b>	L = 42 mm	THICK/SPESS = 0,1 mm	10 pcs/pz	<b>9671</b>	L = 150 mm	THICK/SPESS = 0,10 mm	10 pcs/pz
<b>4167</b>	L = 44 mm	THICK/SPESS = 0,1 mm	10 pcs/pz	<b>9672</b>	L = 150 mm	THICK/SPESS = 0,15 mm	10 pcs/pz
<b>4168</b>	L = 46 mm	THICK/SPESS = 0,1 mm	10 pcs/pz	<b>9673</b>	L = 150 mm	THICK/SPESS = 0,20 mm	10 pcs/pz
<b>4169</b>	L = 48 mm	THICK/SPESS = 0,1 mm	10 pcs/pz	<b>9674</b>	L = 150 mm	THICK/SPESS = 0,30 mm	10 pcs/pz

## OTHER SPARE PARTS

## ALTRE PARTI DI RICAMBIO

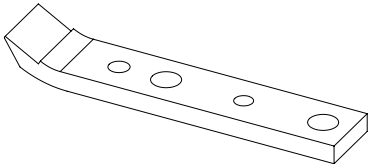
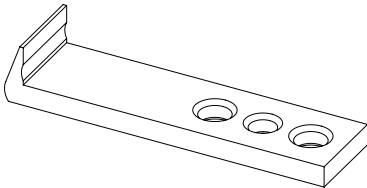
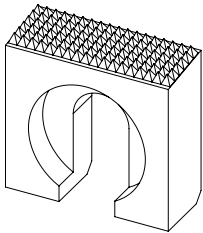
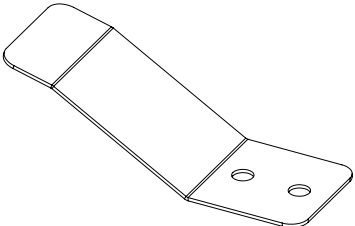
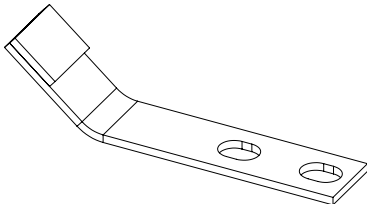
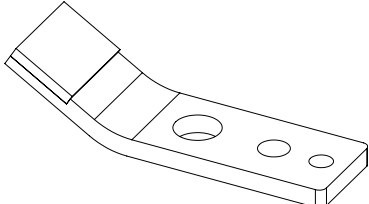
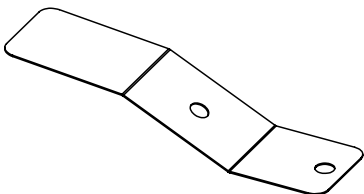
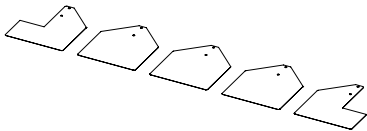
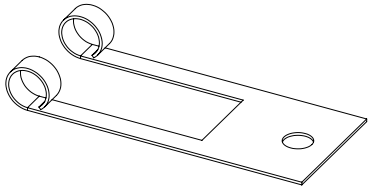
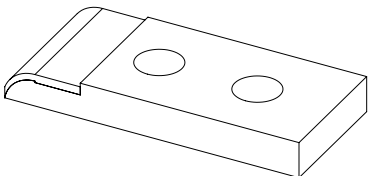
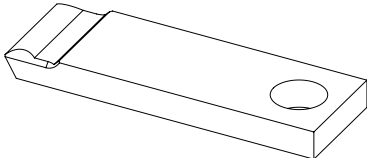
SPEEDMASTER CYLINDER GRIPPER		SPEEDMASTER GRIPPER FINGER		SPEEDMASTER GRIPPER PAD	
PINZA CILINDRO SPEEDMASTER		PINZA CILINDRO SPEEDMASTER		BLOCCHETTO CILINDRO SPEEDMASTER	
					
<b>9528</b>	box 10 - each piece conf. 10 pz - ogni pezzo	<b>9628</b>	each piece ogni pezzo	<b>9626</b>	each piece ogni pezzo
SHEET SMOOTHER SPEEDMASTER		FEEDER GRIPPER HEIDELBERG MO		DELIVERY GRIPPER MO	
LAMELLA GUIDAFOGLI SPEEDMASTER		PINZA METTIFOGLIO HEIDELBERG MO		PINZA USCITA MO	
					
<b>9621</b>	box 10 - each piece conf. 10 pz - ogni pezzo	<b>9519</b>	box 2 - each piece conf. 2 pz - ogni pezzo	<b>9586</b>	box 10 - each piece conf. 10 pz - ogni pezzo
SHEET SMOOTHER KORD 64		HEIDELBERG SHEET SMOOTHER		WHEEL ARM FOR FUJI	
LAMELLA GUIDAFOGLI KORD 64		LAMELLE GUIDAFOGLI HEIDELBERG		PORTAROTELLA FUJI	
					
<b>9620</b>	box 10 - each piece conf. 10 pz - ogni pezzo	<b>1012</b>	kit 3 + 2 lateral kit 3 + 2 laterali	<b>9601</b>	each piece ogni pezzo
PINCER GRIPPER UPPER POSITION		PINCER GRIPPER LOWER POSITION			
PINZA VOLTURA SM - SUPERIORE		PINZA VOLTURA SM - INFERIORE			
					
<b>9678</b>	each piece ogni pezzo	<b>9679</b>	each piece ogni pezzo		

## OTHER SPARE PARTS

## ALTRE PARTI DI RICAMBIO

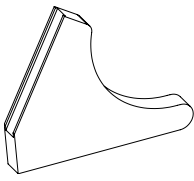
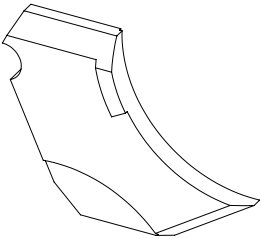
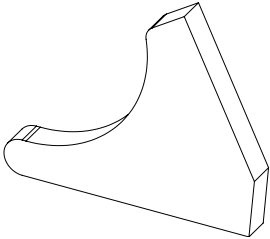
TEFLON SEALS (box 2 pcs - price each box)		TEFLON SEALS FOR TOK		FELT SEALS FOR KOMPAC					
SPALLETTE TEFLON (prezzo per conf. 2 pezzi)		SPALLETTE TEFLON TOK		SPALLETTE IN FELTRO PER KOMPAC					
									
						<b>8003</b>	KOMPAC II		
						<b>8006</b>	KOMPAC III		
<b>8008</b>	KOMPAC V			<b>8010</b>	box 2 - each box conf. 2 pz - ogni confezione				
				<b>8005</b>	box 20 - each box conf. 20 pz - ogni confezione				

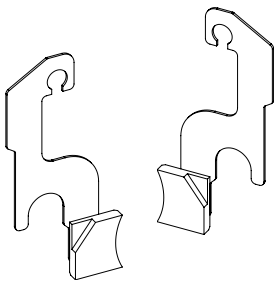
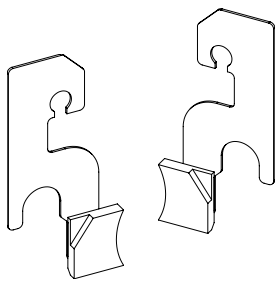
PRINTMASTER END BLOCKS		QUICKMASTER END BLOCKS	
SPALLETTE PRINTMASTER		SPALLETTE QUICKMASTER	
			
<b>9617</b>	RIGHT & LEFT DESTRO e SINISTRO	<b>9618</b>	RIGHT & LEFT DESTRO e SINISTRO

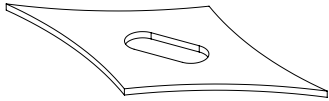
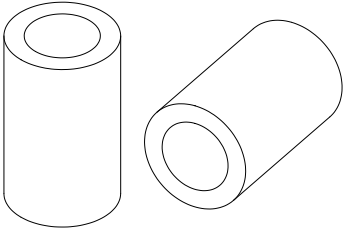
SEPARATOR FOR TIPPING MACHINE		CYLINDRICAL FILTER FOR BALDWIN	
SEPARAFOGLIO PER INCOLLATRICE		FILTRI CILINDRICI PER BALDWIN	
			
<b>9650</b>	Brass 0,80 mm - 10 pieces	<b>4170</b>	Ø ext 115 x 190h x 20 mm
	Ottone 0,80 mm - 10 pezzi	<b>4171</b>	Ø ext 110 x 214h x 20 mm

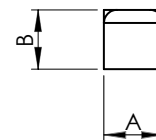
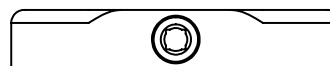
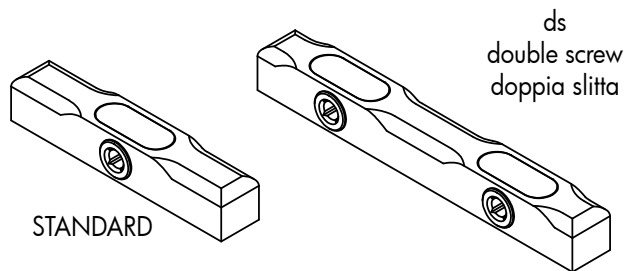

A = 18 mm always / sempre

B = Rg (French Pica / Riga tipografica)

1 Rg = 1 Pica = 1 Cicéro = 4,512 mm

2,5 Rg ≈ 11,3 mm / 4 Rg ≈ 18 mm

Ref. Codice	Model Tipo	Measure Misura	€
<b>6242</b>	KEY FOR QUOINS Rg. 2,5      CHIAVE PER SERRAFORME 2,5 Rg	Rg 2,5 - $\nabla$ 4 mm	
<b>6238</b>	REPLACEMENT PART FOR QUOINS      MECCANISMO DI RICAMBIO	Rg 2,5	
<b>6245</b>	QUOIN      SERRAFORMA	Rg 2,5 x 5 cm	
<b>6246</b>	QUOIN      SERRAFORMA	Rg 2,5 x 7,5 cm	
<b>6247</b>	QUOIN      SERRAFORMA	Rg 2,5 x 10 cm	
<b>6248</b>	QUOIN      SERRAFORMA	Rg 2,5 x 15 cm	
<b>6249</b>	QUOIN      SERRAFORMA	Rg 2,5 x 15 cm ds	
<b>6250</b>	QUOIN      SERRAFORMA	Rg 2,5 x 20 cm ds	
<b>6251</b>	QUOIN      SERRAFORMA	Rg 2,5 x 25 cm ds	
<b>6252</b>	QUOIN      SERRAFORMA	Rg 2,5 x 30 cm ds	

<b>6243</b>	KEY FOR QUOINS Rg. 4      CHIAVE PER SERRAFORME 4 Rg	Rg 4 - $\nabla$ 6 mm	
<b>6239</b>	REPLACEMENT PART FOR QUOINS      MECCANISMO DI RICAMBIO	Rg 4	
<b>6260</b>	QUOIN      SERRAFORMA	Rg 4 x 5 cm	
<b>6261</b>	QUOIN      SERRAFORMA	Rg 4 x 7,5 cm	
<b>6262</b>	QUOIN      SERRAFORMA	Rg 4 x 10 cm	
<b>6263</b>	QUOIN      SERRAFORMA	Rg 4 x 15 cm	
<b>6264</b>	QUOIN      SERRAFORMA	Rg 4 x 15 cm ds	
<b>6265</b>	QUOIN      SERRAFORMA	Rg 4 x 20 cm ds	
<b>6266</b>	QUOIN      SERRAFORMA	Rg 4 x 25 cm ds	
<b>6267</b>	QUOIN      SERRAFORMA	Rg 4 x 30 cm ds	

<b>6244</b>	KEY FOR SAMSON QUOINS      CHIAVE PER SERRAFORME SAMSON		
<b>6338</b>	SAMSON QUOIN      SERRAFORMA SAMSON	N° 2 - 7,5 cm	
<b>6339</b>	SAMSON QUOIN      SERRAFORMA SAMSON	N° 3 - 11 cm	
<b>6340</b>	SAMSON QUOIN      SERRAFORMA SAMSON	N° 4 - 15 cm	
<b>6342</b>	SAMSON QUOIN      SERRAFORMA SAMSON	N° 5 - 19 cm	
<b>6344</b>	SAMSON QUOIN      SERRAFORMA SAMSON	N° 6 - 22 cm	
<b>6348</b>	SAMSON QUOIN      SERRAFORMA SAMSON	N° 8 - 30 cm	

# HICKEY REMOVERS

# RACCOGLI GRUMI

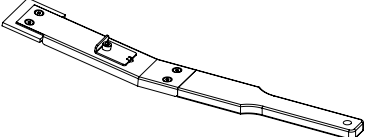
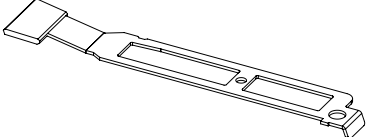
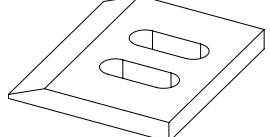
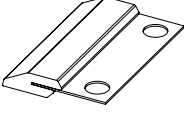
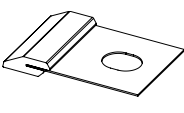
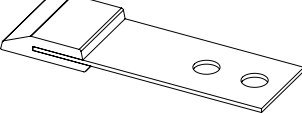
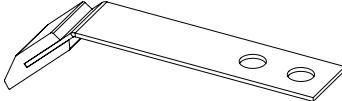
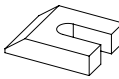
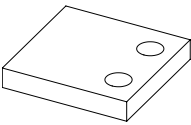
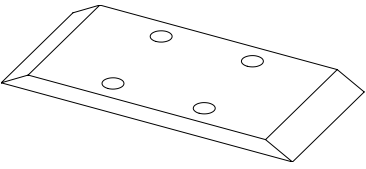
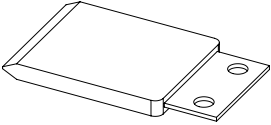
SPEEDMASTER 102 / 102 CD		SPEEDMASTER 105		MITSUBISHI 3F - DIAMOND	
SPEEDMASTER 102 / 102 CD		SPEEDMASTER 105		MITSUBISHI 3F - DIAMOND	
					
<b>9614</b>	COMPLETE / COMPLETO	<b>9611</b>	METAL + RUBBER	<b>5895</b>	RUBBER
<b>5206</b>	RUBBER / GOMMA		METALLO + GOMMA		GOMMA
KBA RAPIDA 104/105		KBA RAPIDA 142/162		MILLER	
KBA RAPIDA 104/105		KBA RAPIDA 142/162		MILLER	
					
<b>5237</b>	FLAT - DRITTO	<b>5236</b>	FLAT - DRITTO	<b>5827</b>	65 mm
<b>5232</b>	BEND - PIEGATO	<b>5234</b>	BEND - PIEGATO	<b>5826</b>	82 mm
MILLER BEND		ROLAND 600 / REKORD		ROLAND 300	
MILLER PIEGATO		ROLAND 600 / REKORD		ROLAND 300	
					
<b>5828</b>	RUBBER+STEEL GOMMA+FERRO	<b>5291</b>	RUBBER GOMMA	<b>5292</b>	RUBBER GOMMA
ROLAND 800		KOMORI LITHRONE 40/440			
ROLAND 800		KOMORI LITHRONE 40/440			
					
<b>5293</b>	RUBBER GOMMA	<b>5868</b>	RUBBER+STEEL GOMMA+FERRO		

Hickey remover on measure on request.

A richiesta levacapperi su misura.

# FLAT SUCKERS FOR FEEDER

# VENTOSE PIATTE PER METTIFOGLIO

**BOX 50 PIECES - PRICE IS FOR EACH PIECE**  
**SCATOLE DA 50 PEZZI - IL PREZZO È RIFERITO ALLA SINGOLA VENTOSA**

### STANDARD COLORS

0,5 mm - Natural rubber (brown)  
 0,8 mm / 1,5 mm - Yellow  
 1,0 mm / 2,0 mm - Light Blue  
 Silicone 1,0 mm / 1,5 mm - Transparent

### COLORI STANDARD

0,5 mm - Gomma naturale (beige)  
 0,8 mm / 1,5 mm - Gialla  
 1,0 mm / 2,0 mm - Azzurra  
 Silicone 1,0 mm / 1,5 mm - Trasparente

Ref. Cod.	External Ø x Internal Ø Ø Esterno x Ø Interno	€		Ref. Cod.	External Ø x Internal Ø Ø Esterno x Ø Interno	€		Ref. Cod.	External Ø x Internal Ø Ø Esterno x Ø Interno	€	
		Rubber Gomma	Silicone			Rubber Gomma	Silicone			Rubber Gomma	Silicone
<b>01</b>	10 x 2 mm			<b>31</b>	27 x 6 mm			<b>61</b>	35 x 12 mm		
<b>02</b>	12 x 1 mm			<b>32</b>	27 x 9 mm			<b>62</b>	35 x 13 mm		
<b>03</b>	13 x 2 mm			<b>33</b>	28 x 6 mm			<b>63</b>	35 x 14 mm		
<b>04</b>	15 x 3 mm			<b>34</b>	28 x 7 mm			<b>64</b>	35 x 15 mm		
<b>05</b>	16 x 2 mm			<b>35</b>	28 x 9 mm			<b>65</b>	36 x 15 mm		
<b>06</b>	17 x 3 mm			<b>36</b>	28 x 12 mm			<b>66</b>	38 x 5 mm		
<b>07</b>	19 x 2 mm			<b>37</b>	29 x 11 mm			<b>67</b>	38 x 9 mm		
<b>08</b>	19 x 3 mm			<b>38</b>	29 x 12 mm			<b>68</b>	38 x 10 mm		
<b>09</b>	19 x 5 mm			<b>39</b>	29 x 14 mm			<b>69</b>	38 x 11 mm		
<b>10</b>	19 x 6 mm			<b>40</b>	30 x 5 mm			<b>70</b>	38 x 12 mm		
<b>11</b>	19 x 7 mm			<b>41</b>	30 x 9 mm			<b>71</b>	38 x 13 mm		
<b>12</b>	20 x 3 mm			<b>42</b>	30 x 11 mm			<b>72</b>	38 x 14 mm		
<b>13</b>	20 x 5 mm			<b>43</b>	30 x 12 mm			<b>73</b>	38 x 15 mm		
<b>14</b>	20 x 11 mm			<b>44</b>	30 x 13 mm			<b>74</b>	39 x 15 mm		
<b>15</b>	21 x 5 mm			<b>45</b>	30 x 14 mm			<b>75</b>	40 x 9 mm		
<b>16</b>	21 x 8 mm			<b>46</b>	32 x 5 mm			<b>76</b>	41 x 9 mm		
<b>17</b>	22 x 3 mm			<b>47</b>	32 x 6 mm			<b>77</b>	41 x 12 mm		
<b>18</b>	22 x 5 mm			<b>48</b>	32 x 9 mm			<b>78</b>	41 x 14 mm		
<b>19</b>	22 x 6 mm			<b>49</b>	32 x 10 mm			<b>79</b>	41 x 16 mm		
<b>20</b>	22 x 8 mm			<b>50</b>	32 x 11 mm			<b>90</b>	42 x 15 mm		
<b>21</b>	22 x 9 mm			<b>51</b>	32 x 12 mm			<b>80</b>	44 x 8 mm		
<b>22</b>	24 x 5 mm			<b>52</b>	32 x 13 mm			<b>81</b>	45 x 13 mm		
<b>23</b>	24 x 6 mm			<b>53</b>	32 x 14 mm			<b>82</b>	45 x 14 mm		
<b>24</b>	24 x 9 mm			<b>54</b>	32 x 15 mm			<b>83</b>	45 x 15 mm		
<b>25</b>	24 x 12 mm			<b>55</b>	32 x 16 mm			<b>84</b>	45 x 16 mm		
<b>26</b>	25 x 5 mm			<b>56</b>	33 x 15 mm			<b>85</b>	45 x 17 mm		
<b>27</b>	25 x 6 mm			<b>57</b>	35 x 5 mm			<b>86</b>	50 x 6 mm		
<b>91</b>	25 x 8 mm			<b>58</b>	35 x 6 mm			<b>87</b>	50 x 8 mm		
<b>28</b>	25 x 9 mm			<b>59</b>	35 x 9 mm			<b>88</b>	50 x 13 mm		
<b>29</b>	27 x 3 mm			<b>60</b>	35 x 10 mm			<b>89</b>	50 x 14 mm		
<b>30</b>	27 x 5 mm										

**FOR MORE INFORMATION, PHOTOS AND DRAWINGS PLEASE REFER TO OUR SUCKERS CATALOGUE**  
**PER MAGGIORI INFORMAZIONI, FOTO E DISEGNI FATE RIFERIMENTO AL NOSTRO CATALOGO VENTOSE**



# SHAPED SUCKERS FOR FEEDER VENTOSE SAGOMATE PER METTIFOGLIO

**BOX 50 PIECES - PRICE IS FOR EACH PIECE  
SCATOLE DA 50 PEZZI - IL PREZZO È RIFERITO ALLA SINGOLA VENTOSA**

Ref. Cod.	Ext. Ø × Int. Ø × Thick. Ø Est. × Ø Int. × Spess.	€
0126	17 × 7 × 8	
0128	19 × 7 × 3	
0130	27 × 7 × 6	
0132	28 × 18 × 7	
0134	16 × 8 × 20	
0136	20 × 6 × 3	
0138	18 × 4 × 5	
0141	22 × 8 × 6	
0142	24 × 6 × 13	
0144	20 × 6 × 9	
0146	16 × 2 × 13	
0148	25,5 × 7 × 9,5	
0150	30 × 5,5 × 12	
0152	15 × 2,5 × 12	
0154	21 × 6 × 15	
0156	17 × 6 × 21	
0158	20 × 5 × 20,5	
0160	32 × 11 × 25	
0162	27 × 10 × 23	
0164	22 × 6 × 22	
0166	26 × 5 × 20	
0168	18 × 8 × 20	
0170	17 × 12 × 14,5	
0172	30 × 8 × 33	
0174	36 × 11 × 13	
0176	20x16 × 5 × 14,5	
0178	14x10 × 5 × 13	
0180	35 × 10 × 27	
0182	16,5 × 7 × 10,5	
0184	18 × 6 × 7	

Ref. Cod.	Ext. Ø × Int. Ø × Thick. Ø Est. × Ø Int. × Spess.	€
0186	24 × 14 × 6	
0188	15 × 6 × 8	
0190	18 × 6 × 11	
0191	32 × 5 × 10	
0192	42 × 6 × 15	
0194	15 × 7 × 12	
0195	22 × 6 × 23	
0196	46 × 16 × 50	
0197	26 × 8 × 8	
0198	27,5 × 15 × 6,5	
0200	25 × 6 × 15	
0202	22 × 6 × 7,5	
0204	15 × 5 × 2,5	
0206	35 × 6 × 20	
0208	15 × 4 × 4,5	
0210	13 × 7 × 12	
0212	12 × 6 × 9	
0214	18 × 6 × 9,5	
0216	15 × 7 × 9	
0218	30 × 15 × 17,5	
0220	46 × 17 × 9,5	
0222	15 × 5,5 × 16	
0224	22 × 6 × 16,5	
0226	14 × 5 × 14	
0228	17 × 3,5 × 18	
0230	41 × 16 × 14	
0232	20 × 5 × 14,5	
0234	21 × 5 × 4	
0236	16 × 4,5 × 17	
0238	20 × 6 × 10	

Ref. Cod.	Ext. Ø × Int. Ø × Thick. Ø Est. × Ø Int. × Spess.	€
0239	20 × 4 × 10	
0240	20x12 × 2 × 7	
0242	20 × 11 × 19	
0243	8 × 3 × 7,5	
0244	31 × 17,5 × 1,5	
0245	19,5 × 3 × 17,5	
0246	27 × 9,5 × 1,5	
0247	17 × 5 × 11	
0248	30 × 8 × 27	
0249	15,5 × 5 × 31	
0250	63 × 16 × 53	
0251	16,5x12 × 12,5 × 36	
0252	19 × 6 × 24	
0253	25 × 6 × 17	
0254	16 × 8 × 20	
0255	25 × 5 × 21	
0256	17,5 × 5 × 10,5	
0257	15,5 × 6 × 11	
0258	17,5 × 3 × 12,5	
0259	60 × M8 × 20	
0260	28 × 16 × 3	
0261	27 × 6 × 10	

**FOR MORE INFORMATION, PHOTOS AND DRAWINGS PLEASE REFER TO OUR SUCKERS CATALOGUE  
PER MAGGIORI INFORMAZIONI, FOTO E DISEGNI FATE RIFERIMENTO AL NOSTRO CATALOGO VENTOSE**

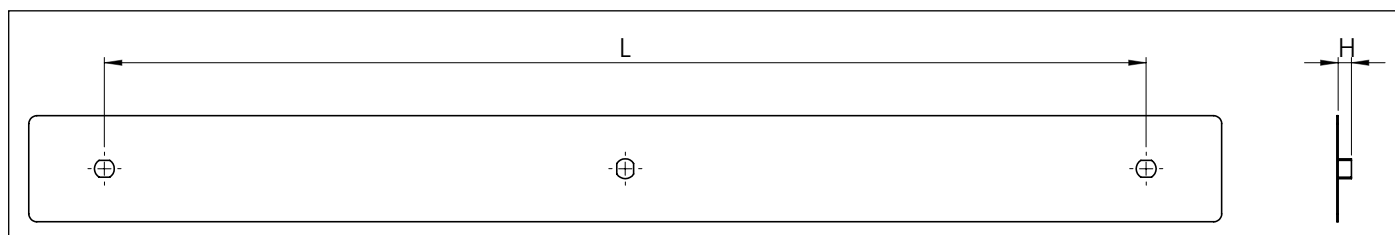

Ref Cod.	Lenght (L) Lunghezza (L)	Height (H) Altezza (H)	Pin Number Numero Pin	Pin Size Dim. Pin A x B		€
<b>441982</b>	198 mm	2 mm	2	5 x 6,5 + Ø 5 mm		
<b>441985</b>	198 mm	5 mm	2	5 x 6,5 + Ø 5 mm		
<b>443932</b>	393 mm	2 mm	3	6,35 x 7,5 mm		
<b>443935</b>	393 mm	5 mm	3	6,35 x 7,5 mm		
<b>447482</b>	748 mm	2 mm	3	6,35 x 7,5 mm		
<b>447485</b>	748 mm	5 mm	3	6,35 x 7,5 mm		
<b>447487</b>	393 + 748 mm	2 mm	5	6,35 x 7,5 mm		
<b>447489</b>	393 + 748 mm	5 mm	5	6,35 x 7,5 mm		
<b>444002</b>	400 mm	2 mm	3	5 x 6,5 mm		
<b>444005</b>	400 mm	5 mm	3	5 x 6,5 mm		
<b>447552</b>	755 mm	2 mm	3	5 x 6,5 mm		
<b>447555</b>	755 mm	5 mm	3	5 x 6,5 mm		
<b>441172</b>	1.175 mm	2 mm	3	5 x 6,5 mm		
<b>441175</b>	1.175 mm	5 mm	3	5 x 6,5 mm		

On request custom or combined pin bar configuration  
 A richiesta barrette di montaggio combinate o personalizzate

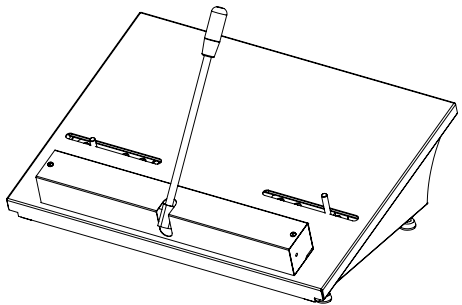
TABLE REGISTER PUNCHES PT 650 and PT 840	price starting from €
PUNZONATRICI DA TAVOLO PT 650 e PT 840	prezzi a partire da €
	<ul style="list-style-type: none"> <li>PT 650: FOR PLATES 35x50 (PLATES UP TO 650mm).</li> <li>PT 840: FOR PLATES 50x70 (PLATES UP TO 840mm).</li> <li>MANUAL OPERATION BY HANDLE</li> </ul>
	<ul style="list-style-type: none"> <li>PT 650: PER LASTRE FORMATO 35x50 (FINO A 650 mm).</li> <li>PT 840: PER LASTRE FORMATO 50x70 (FINO A 840 mm).</li> <li>COMANDO MANUALE A LEVA</li> </ul>

REGISTER PUNCHES PLP 920 - PLP 1200 - PLP 1820	price starting from €	
PUNZONATRICI PLP 920 - PLP 1200 - PLP 1820	prezzi a partire da €	
	<ul style="list-style-type: none"> <li>• FOR PLATES 50x70 (PLP 920), 70x100 (PLP 1200) and 120x160 (PLP 1820).</li> <li>• MECHANICAL OPERATION VIA FOOT PEDAL OR PNEUMATIC VIA PUSH BUTTON.</li> </ul>	
	<ul style="list-style-type: none"> <li>• PER LASTRE FORMATO 50x70 (PLP 920), 70x100 (PLP 1200) e 120x160 (PLP 1820).</li> <li>• COMANDO A PEDALE O PNEUMATICO A PULSANTE.</li> </ul>	

PLATE BENDER BLC-50 FOR 35x50 OFFSET PLATES	price starting from €	
PIEGALASTRE BLC-50 PER LASTRE 35x50	prezzi a partire da €	
	<ul style="list-style-type: none"> <li>• FOR PLATES 35x50.</li> <li>• MANUAL OPERATION BY SINGLE HANDLE.</li> </ul>	
	<ul style="list-style-type: none"> <li>• PER LASTRE FORMATO 35x50.</li> <li>• COMANDO MANUALE A SINGOLA LEVA.</li> </ul>	

PLATE BENDER and PUNCH BENDERS	price starting from €	
PIEGALASTRE E PIEGALASTRE-PUNZONATRICE	prezzi a partire da €	
	<ul style="list-style-type: none"> <li>• SUITABLE FOR HEIDELBERG and KOMORI 50x70 (BL 70 - BLC 70) and 70x100 (BL 100 - BLC 100) PRINTING MACHINES.</li> <li>• MANUAL OPERATION BY SINGLE HANDLE OR PNEUMATIC VIA PUSH BUTTON.</li> </ul>	
	<ul style="list-style-type: none"> <li>• DISPONIBILE PER MACCHINE HEIDELBERG E KOMORI FORMATO 50x70 (BL 70 - BLC 70) E 70x100 (BL 100 - BLC 100).</li> <li>• COMANDO MANUALE A LEVA SINGOLA O PNEUMATICO A PULSANTE.</li> </ul>	

## PLASTIC JOGGING BLOCKS

## SPINGI-CARTA IN PLASTICA

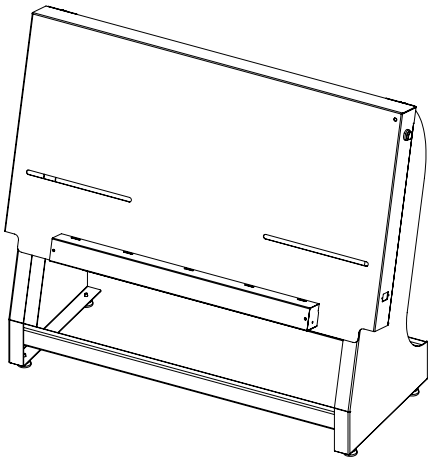
Ref. Codice	Size (A x B) Dimensioni (A x B)	€
<b>3450</b>	200 x 75 mm	
<b>3451</b>	250 x 75 mm	
<b>3452</b>	200 x 100 mm	
<b>3453</b>	250 x 100 mm	
<b>3454</b>	300 x 100 mm	
<b>3455</b>	250 x 125 mm	
<b>3456</b>	300 x 125 mm	
<b>3457</b>	400 x 125 mm	
<b>3458</b>	450 x 125 mm	
<b>3459</b>	300 x 150 mm	
<b>3460</b>	400 x 150 mm	
<b>3461</b>	450 x 150 mm	
<b>3462</b>	650 x 150 mm - double handle / doppio manico	

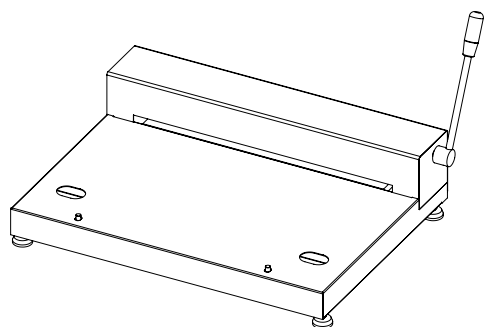
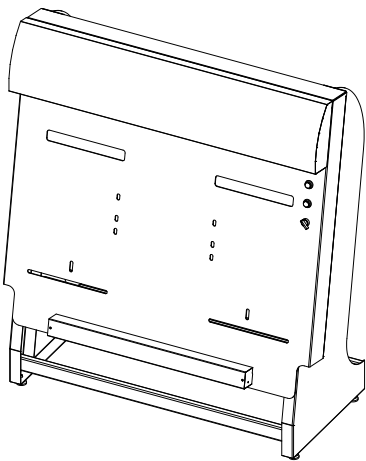
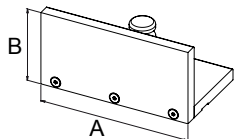

## WOODEN JOGGING BLOCKS

## SPINGI-CARTA IN LEGNO

Ref. Codice	Size (A x B) Dimensioni (A x B)	€
<b>3550</b>	200 x 75 mm	
<b>3551</b>	250 x 75 mm	
<b>3552</b>	200 x 100 mm	
<b>3553</b>	250 x 100 mm	
<b>3554</b>	300 x 100 mm	
<b>3555</b>	250 x 125 mm	
<b>3556</b>	300 x 125 mm	
<b>3557</b>	400 x 125 mm	
<b>3558</b>	450 x 125 mm	
<b>3559</b>	300 x 150 mm	
<b>3560</b>	400 x 150 mm	
<b>3561</b>	450 x 150 mm	
<b>3562</b>	650 x 150 mm - double handle / doppio manico	

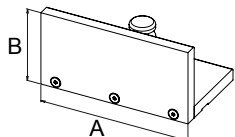

# CUTTING STICKS

# LISTELLI SOTTOLAMA

Ref. Codice	Machine Macchina	Color & type Colore e tipo	Measure Misura	€
<b>8882</b>	POLAR 55/58/66/71/72	RED WAVY / ROSSO ONDULATO	10 x 4,5 x 730	
<b>8883</b>	POLAR 76/78	RED WAVY / ROSSO ONDULATO	10 x 4,5 x 790	
<b>8884</b>	POLAR 80/82	RED WAVY / ROSSO ONDULATO	10 x 4,5 x 830	
<b>8886</b>	POLAR 86/90/92	RED WAVY / ROSSO ONDULATO	10 x 4,5 x 930	
<b>8888</b>	POLAR 105/107	RED WAVY / ROSSO ONDULATO	10 x 4,5 x 1.080	
<b>8889</b>	POLAR 112/115	RED WAVY / ROSSO ONDULATO	10 x 4,5 x 1.160	
<b>8890</b>	POLAR 132	RED WAVY / ROSSO ONDULATO	10 x 4,5 x 1.330	
<b>8892</b>	POLAR 137/145	RED WAVY / ROSSO ONDULATO	10 x 4,5 x 1.460	
<b>8894</b>	POLAR 150/155	RED WAVY / ROSSO ONDULATO	10 x 4,5 x 1.560	
<b>8895</b>	POLAR 176	RED WAVY / ROSSO ONDULATO	10 x 4,5 x 1.770	
<b>8896</b>	POLAR 80/82	GREY WAVY / GRIGIO ONDULATO	10 x 4,5 x 830	
<b>8897</b>	POLAR 92	GREY WAVY / GRIGIO ONDULATO	10 x 4,5 x 930	
<b>8898</b>	POLAR 105/107	GREY WAVY / GRIGIO ONDULATO	10 x 4,5 x 1.080	
<b>8899</b>	POLAR 115	GREY WAVY / GRIGIO ONDULATO	10 x 4,5 x 1.160	
<b>8901</b>	POLAR 155	GREY WAVY / GRIGIO ONDULATO	10 x 4,5 x 1.560	
<b>8902</b>	WOHLEMBERG	RED STRAIGHT / ROSSO DRITTO	18 x 4 x 878	
<b>8904</b>	WOHLEMBERG	RED STRAIGHT / ROSSO DRITTO	18 x 4 x 1.080	
<b>8906</b>	WOHLEMBERG	RED STRAIGHT / ROSSO DRITTO	18 x 4 x 1.335	
<b>8908</b>	WOHLEMBERG	RED STRAIGHT / ROSSO DRITTO	18 x 4 x 1.560	
<b>8910</b>	WOHLEMBERG	RED STRAIGHT / ROSSO DRITTO	11 x 3 x 909	
<b>8912</b>	WOHLEMBERG	RED STRAIGHT / ROSSO DRITTO	11 x 3 x 1.157	
<b>8914</b>	WOHLEMBERG	RED STRAIGHT / ROSSO DRITTO	13 x 13 x 926	
<b>8915</b>	WOHLEMBERG	RED STRAIGHT / ROSSO DRITTO	13 x 13 x 1.157	
<b>8916</b>	WOHLEMBERG	RED STRAIGHT / ROSSO DRITTO	15 x 15 x 1.157	
<b>8917</b>	WOHLEMBERG	RED WAVY / ROSSO ONDULATO	10 x 4 x 770	
<b>8918</b>	WOHLEMBERG	RED WAVY / ROSSO ONDULATO	10 x 4 x 930	
<b>8919</b>	WOHLEMBERG	RED WAVY / ROSSO ONDULATO	10 x 4 x 1.190	
<b>8909</b>	WOHLEMBERG	GREY STRAIGHT / GRIGIO DRITTO	18 x 4 x 1.560	
<b>8913</b>	WOHLEMBERG	GREY STRAIGHT / GRIGIO DRITTO	11 x 3 x 1.157	
<b>8921</b>	WOHLEMBERG	GREY WAVY / GRIGIO ONDULATO	10 x 4 x 770	
<b>8923</b>	WOHLEMBERG	GREY WAVY / GRIGIO ONDULATO	10 x 4 x 930	
<b>8925</b>	WOHLEMBERG	GREY WAVY / GRIGIO ONDULATO	10 x 4 x 1.190	
<b>8920</b>	WOHLEMBERG	GREY STRAIGHT / GRIGIO DRITTO	13 x 13 x 1.157	

Ref. Codice	Machine Macchina	Color & type Colore e tipo	Measure Misura	€
<b>8922</b>	SCHNEIDER SENATOR	RED STRAIGHT / ROSSO DRITTO	12 x 3 x 821	
<b>8924</b>	SCHNEIDER SENATOR	RED STRAIGHT / ROSSO DRITTO	12 x 3 x 1.151	
<b>8926</b>	SCHNEIDER SENATOR	RED STRAIGHT / ROSSO DRITTO	12 x 3 x 1.551	
<b>8930</b>	SCHNEIDER SENATOR	RED STRAIGHT / ROSSO DRITTO	14 x 14 x 821	
<b>8932</b>	SCHNEIDER SENATOR	RED STRAIGHT / ROSSO DRITTO	14 x 14 x 1.061	
<b>8934</b>	SCHNEIDER SENATOR	RED STRAIGHT / ROSSO DRITTO	14 x 14 x 1.370	
<b>8935</b>	SCHNEIDER SENATOR	RED STRAIGHT / ROSSO DRITTO	14 x 14 x 1.600	
<b>8927</b>	SCHNEIDER SENATOR	GREY STRAIGHT / GRIGIO DRITTO	12 x 3 x 1.151	
<b>8942</b>	MANDELLI LLM	RED STRAIGHT / ROSSO DRITTO	16 x 16 x 765	
<b>8944</b>	MANDELLI LLM	RED STRAIGHT / ROSSO DRITTO	16 x 16 x 930	
<b>8946</b>	MANDELLI LLM	RED STRAIGHT / ROSSO DRITTO	16 x 16 x 1.080	
<b>8948</b>	MANDELLI LLM	RED STRAIGHT / ROSSO DRITTO	16 x 16 x 1.335	
<b>8950</b>	MANDELLI LLM	RED STRAIGHT / ROSSO DRITTO	16 x 16 x 1.575	
<b>8949</b>	MANDELLI LLM	GREY STRAIGHT / GRIGIO DRITTO	16 x 16 x 1.575	
<b>8951</b>	HEROLD	RED STRAIGHT / ROSSO DRITTO	18 x 5 x 840	
<b>8952</b>	HEROLD	RED STRAIGHT / ROSSO DRITTO	18 x 5 x 930	
<b>8953</b>	HEROLD	RED STRAIGHT / ROSSO DRITTO	18 x 5 x 1.080	
<b>8954</b>	HEROLD	RED STRAIGHT / ROSSO DRITTO	18 x 5 x 1.160	
<b>8962</b>	PIVANO PERFECTA	RED STRAIGHT / ROSSO DRITTO	10 x 5 x 840	
<b>8963</b>	PIVANO PERFECTA	RED STRAIGHT / ROSSO DRITTO	10 x 5 x 1.138	
<b>8964</b>	PIVANO PERFECTA	RED STRAIGHT / ROSSO DRITTO	10 x 5 x 1.368	
<b>8965</b>	PIVANO PERFECTA	RED STRAIGHT / ROSSO DRITTO	10 x 5 x 1.715	
<b>8968</b>	PIVANO PERFECTA	RED STRAIGHT / ROSSO DRITTO	19 x 19 x 838	
<b>8969</b>	PIVANO PERFECTA	RED STRAIGHT / ROSSO DRITTO	19 x 19 x 1.073	
<b>8970</b>	PIVANO PERFECTA	RED STRAIGHT / ROSSO DRITTO	19 x 19 x 1.130	
<b>8971</b>	PIVANO PERFECTA	RED STRAIGHT / ROSSO DRITTO	12 x 4 x 1.070	
<b>8976</b>	SAROGLIA	RED STRAIGHT / ROSSO DRITTO	20 x 20 x 890	
<b>8977</b>	SAROGLIA	RED STRAIGHT / ROSSO DRITTO	20 x 20 x 1.065	
<b>8978</b>	SAROGLIA	RED STRAIGHT / ROSSO DRITTO	20 x 20 x 1.325	
<b>8980</b>	PIVANO SAROGLIA	RED STRAIGHT / ROSSO DRITTO	10 x 10 x 850	
<b>8981</b>	PIVANO SAROGLIA	RED STRAIGHT / ROSSO DRITTO	10 x 10 x 1.095	
<b>8982</b>	PIVANO SAROGLIA	RED STRAIGHT / ROSSO DRITTO	10 x 10 x 1.325	

# CUTTING STICKS

# LISTELLI SOTTOLAMA

Ref. Codice	Machine Macchina	Color & type Colore e tipo	Measure Misura	€
<b>8870</b>	IDEAL with 4 holes - con 4 fori	RED STRAIGHT / ROSSO DRITTO	14 x 14 x 453	
<b>8872</b>	IDEAL with 4 holes - con 4 fori	RED STRAIGHT / ROSSO DRITTO	14 x 14 x 570	
<b>8874</b>	IDEAL with 4 holes - con 4 fori	RED STRAIGHT / ROSSO DRITTO	14 x 14 x 645	
<b>8876</b>	IDEAL with 4 holes - con 4 fori	RED STRAIGHT / ROSSO DRITTO	14 x 14 x 765	
<b>8878</b>	IDEAL with 4 holes - con 4 fori	RED STRAIGHT / ROSSO DRITTO	14 x 14 x 885	
<b>8955</b>	THREELATERAL / TRILATERALE	RED STRAIGHT / ROSSO DRITTO	24 x 4 x 1.200	
<b>8956</b>	THREELATERAL / TRILATERALE	RED STRAIGHT / ROSSO DRITTO	41 x 4 x 1.200	
<b>8957</b>	THREELATERAL / TRILATERALE	RED STRAIGHT / ROSSO DRITTO	60 x 4 x 1.200	
<b>8958</b>	THREELATERAL / TRILATERALE	RED STRAIGHT / ROSSO DRITTO	11 x 4 x 1.200	
<b>8959</b>	THREELATERAL / TRILATERALE	RED STRAIGHT / ROSSO DRITTO	13 x 4 x 1.200	
<b>8865</b>	THREELATERAL / TRILATERALE	GREY STRAIGHT / GRIGIO DRITTO	24 x 4 x 1.200	
<b>8866</b>	THREELATERAL / TRILATERALE	GREY STRAIGHT / GRIGIO DRITTO	41 x 4 x 1.200	
<b>8867</b>	THREELATERAL / TRILATERALE	GREY STRAIGHT / GRIGIO DRITTO	60 x 4 x 1.200	
<b>8868</b>	THREELATERAL / TRILATERALE	GREY STRAIGHT / GRIGIO DRITTO	11 x 4 x 1.200	
<b>8869</b>	THREELATERAL / TRILATERALE	GREY STRAIGHT / GRIGIO DRITTO	13 x 4 x 1.200	
<b>8983</b>	OMAC NEBIOLO	RED STRAIGHT / ROSSO DRITTO	9,5 x 5 x 1.505	
<b>8984</b>	OMAC NEBIOLO	RED STRAIGHT / ROSSO DRITTO	9,7 x 5 x 760	
<b>8985</b>	OMAC NEBIOLO	RED STRAIGHT / ROSSO DRITTO	9,7 x 5 x 840	
<b>8986</b>	OMAC NEBIOLO	RED STRAIGHT / ROSSO DRITTO	9,7 x 5 x 1.120	
<b>8987</b>	OMAC NEBIOLO	RED STRAIGHT / ROSSO DRITTO	9,7 x 5 x 1.230	
<b>8988</b>	OMAC NEBIOLO	RED STRAIGHT / ROSSO DRITTO	9,7 x 5 x 1.500	
<b>8989</b>	OMAC NEBIOLO	RED STRAIGHT / ROSSO DRITTO	15 x 15 x 760	
<b>8990</b>	OMAC NEBIOLO	RED STRAIGHT / ROSSO DRITTO	15 x 15 x 830	
<b>8991</b>	OMAC NEBIOLO	RED STRAIGHT / ROSSO DRITTO	15 x 15 x 930	
<b>8992</b>	OMAC NEBIOLO	RED STRAIGHT / ROSSO DRITTO	15 x 15 x 1.120	
<b>8993</b>	OMAC NEBIOLO	RED STRAIGHT / ROSSO DRITTO	15 x 15 x 1.320	
<b>8994</b>	OMAC NEBIOLO	RED STRAIGHT / ROSSO DRITTO	15 x 15 x 1.555	
<b>8996</b>	F.T.P.	RED STRAIGHT / ROSSO DRITTO	16 x 5 x 820	
<b>8997</b>	F.T.P.	RED STRAIGHT / ROSSO DRITTO	16 x 5 x 1.070	
<b>8998</b>	F.T.P.	RED STRAIGHT / ROSSO DRITTO	16 x 5 x 1.120	
<b>8999</b>	F.T.P.	RED STRAIGHT / ROSSO DRITTO	16 x 5 x 1.150	
<b>8891</b>	VICKING	RED STRAIGHT / ROSSO DRITTO	10 x 30 x 230	
<b>8893</b>	CITOBORMA	RED STRAIGHT / ROSSO DRITTO	40 x 3 x 496	

# CHANNEL

## STANDARD

**STEEL BASE 9 mm - 750 mm LONG. / BASE IN ACCIAIO da 9 mm - PEZZI DA 750 mm**

Ref. Codice	Color Colore	Depth Profondità	Width Larghezza	Grams Grammi	µm	Meters Metri	€
<b>7170</b>	GOLD ORO	0,38 mm	0,56 mm	50/150	> 150	24	
<b>7172</b>	ORANGE ARANCIO	0,38 mm	0,80 mm	100/150	> 150	24	
<b>7174</b>	BUFF CAMOSCIO	0,38 mm	1,00 mm	150/200	> 250	24	
<b>7176</b>	WHITE BIANCO	0,43 mm	1,30 mm	200/275	200 - 400	24	
<b>7178</b>	YELLOW GIALLO	0,48 mm	1,50 mm	275/335	350 - 500	24	
<b>7180</b>	MAUVE MALVA	0,53 mm	1,70 mm	335/400	450 - 600	24	
<b>7182</b>	GREEN VERDE	0,58 mm	1,90 mm	400/465	500 - 700	24	
<b>7184</b>	MAROON MATTONE	0,63 mm	2,10 mm	465/535	650 - 800	24	
<b>7186</b>	RED ROSSO	0,68 mm	2,30 mm	535/600	750 - 900	24	
<b>7188</b>	BLUE BLU	0,79 mm	2,70 mm	600/665	850 - 1.000	24	
<b>7190</b>	BROWN MARRONE	1,00 mm	3,00 mm	665/750	950 - 1.200	12	

# CHANNEL

## OFF CENTRE (2 mm) / LATERALE (2 mm)

**STEEL BASE 9 mm - 750 mm LONG. / BASE IN ACCIAIO da 9 mm - PEZZI DA 750 mm**

Ref. Codice	Color Colore	Depth Profondità	Width Larghezza	Grams Grammi	µm	Meters Metri	€
<b>7200</b>	BUFF CAMOSCIO	0,38 mm	1,00 mm	150/200	> 250	24	
<b>7202</b>	WHITE BIANCO	0,43 mm	1,30 mm	200/275	200 - 400	24	
<b>7204</b>	YELLOW GIALLO	0,48 mm	1,50 mm	275/335	350 - 500	24	

# CHANNEL

## DOUBLE (3 mm) / DOPPIO (3 mm)

**STEEL BASE 9 mm - 750 mm LONG. / BASE IN ACCIAIO da 9 mm - PEZZI DA 750 mm**

Ref. Codice	Color Colore	Depth Profondità	Width Larghezza	Grams Grammi	µm	Meters Metri	€
<b>7212</b>	WHITE BIANCO	0,43 mm	1,30 mm	200/275	200 - 400	12	

Ref. Codice	<b>7266</b>
	
CUTTING PRESS FOR MATRIX PRESSA TAGLIA CANALETTO	
€	

Ref. Codice	<b>7268</b>
	
CUTTING GRIPPER FOR MATRIX PINZA TAGLIA CANALETTO	
€	



**XTC**

**STANDARD**

**PVC BASE 9 mm - 750 mm LONG. / BASE IN PVC da 9 mm - PEZZI DA 750 mm**

Ref. Codice	Color Colore	Use with Uso	Depth Profondità	Width Larghezza	Grams Grammi	µm	Meters Metri	€
<b>7402</b>	PINK ROSA	Cardboard	0,3 mm	0,80 mm	100/150	> 150	24	
<b>7404</b>	GREY GRIGIO	Cardboard	0,4 mm	1,00 mm	150/200	150 - 250	24	
<b>7406</b>	WHITE BIANCO	Cardboard	0,5 mm	1,30 mm	200/275	200 - 400	24	
<b>7408</b>	DARK BLUE BLU	Cardboard	0,5 mm	1,50 mm	275/335	350 - 500	24	
<b>7410</b>	YELLOW GIALLO	Cardboard	0,6 mm	1,70 mm	335/400	450 - 650	24	
<b>7412</b>	YELLOW GIALLO	Cardboard	0,6 mm	1,90 mm	400/465	575 - 775	24	
<b>7414</b>	BROWN MARRONE	Cardboard	0,8 mm	2,30 mm	465/600	750 - 900	24	
<b>7416</b>	LIGHT BLUE AZZURRO	Cardboard microwaves	0,8 mm	2,50 mm	600/750	875 - 1.200	24	

**XTC**

**OFF CENTRE / LATERALE**

**PVC BASE 9 mm - 750 mm LONG. / BASE IN PVC da 9 mm - PEZZI DA 750 mm**

Ref. Codice	Color Colore	Use with Uso	Depth Profondità	Width Larghezza	Grams Grammi	µm	Meters Metri	€
<b>7420</b>	GREY GRIGIO	Cardboard	0,4 mm	1,00 mm	150/200	150 - 250	24	
<b>7422</b>	WHITE BIANCO	Cardboard	0,5 mm	1,30 mm	200/275	200 - 400	24	
<b>7424</b>	WHITE BIANCO	Cardboard	0,5 mm	1,50 mm	275/335	350 - 500	24	
<b>7426</b>	YELLOW GIALLO	Cardboard	0,6 mm	1,70 mm	335/400	450 - 650	24	

**PRIME**

**STANDARD**

**CARDBOARD BASE 12 mm - 750 mm LONG. / BASE IN CARTONE da 12 mm - PEZZI DA 750 mm**

Ref. Codice	Color Colore	N°	Depth Profondità	Width Larghezza	Grams Grammi	µm	Meters Metri	€
<b>7302</b>	PINK ROSA	N. 0	0,3 mm	0,80 mm	100/150	> 150	18	
<b>7304</b>	GREY GRIGIO	N. 1	0,4 mm	1,00 mm	150/200	150 - 250	18	
<b>7306</b>	WHITE BIANCO	N. 2	0,5 mm	1,30 mm	200/275	200 - 400	18	
<b>7308</b>	DARK BLUE BLU	N. 3	0,5 mm	1,50 mm	275/335	350 - 500	18	
<b>7310</b>	YELLOW GIALLO	N. 4	0,6 mm	1,70 mm	335/400	450 - 650	18	
<b>7312</b>	GREEN VERDE	N. 5	0,6 mm	1,90 mm	400/465	575 - 775	18	
<b>7314</b>	BROWN MARRONE	N. 6	0,8 mm	2,30 mm	465/600	750 - 900	18	
<b>7316</b>	LIGHT BLUE AZZURRO	N. 7	0,8 mm	2,50 mm	600/750	875 - 1.200	18	
<b>7318</b>	RED ROSSO	N. 8	1,0 mm	3,00 mm	solid board	-	18	
<b>7320</b>	VIOLET VIOLA	N. 8a	1,0 mm	3,50 mm	solid board	-	18	
<b>7322</b>	BLACK (base 15 mm) NERO	N. 9	1,0 mm	4,00 mm	heavy solid board	-	15	
<b>7324</b>	GOLD (base 15 mm) ORO	N. 10	1,0 mm	5,00 mm	heavy solid board	-	15	

**STEEL STAPLES**
**PUNTI METALLICI**

# NAGEL

BOX OF 5.000 STAPLES / SCATOLINE DA 5.000 PUNTI





Ref. Codice	Model Tipo	Measure Misura	€
<b>8806</b>	STEEL STAPLES	PUNTI METALLICI 50/6	
<b>8808</b>	STEEL STAPLES	PUNTI METALLICI 50/8	
<b>8810</b>	HARDENED STEEL STAPLES	PUNTI METALLICI 50/10 S	
<b>8812</b>	HARDENED STEEL STAPLES	PUNTI METALLICI 50/12 S	
<b>8815</b>	HARDENED STEEL STAPLES	PUNTI METALLICI 50/15 S	
<b>8818</b>	HARDENED STEEL STAPLES	PUNTI METALLICI 50/18 S	
<b>8820</b>	HARDENED STEEL STAPLES	PUNTI METALLICI 50/20 S	
<b>8826</b>	STEEL STAPLES	PUNTI METALLICI 26/6 - RAPID 66/6	
<b>8828</b>	HARDENED STEEL STAPLES	PUNTI METALLICI 26/8 S - RAPID 66/8	
<b>8829</b>	LOOP STEEL STAPLES	PUNTI METALLICI con $\Omega$ Ri 26/6 - RAPID 66 RING	
<b>8836</b>	STEEL STAPLES	PUNTI METALLICI 24/6 - RAPID 44/6	
<b>8838</b>	STEEL STAPLES	PUNTI METALLICI 24/8 - RAPID 44/8	
<b>8840</b>	HARDENED STEEL STAPLES	PUNTI METALLICI 24/10 S	
<b>8843</b>	HARDENED STEEL STAPLES	PUNTI METALLICI 24/13 S	
<b>8845</b>	HARDENED STEEL STAPLES	PUNTI METALLICI 24/15 S	
<b>8848</b>	HARDENED STEEL STAPLES	PUNTI METALLICI 24/18 S	
<b>8850</b>	LOOP STEEL STAPLES	PUNTI METALLICI con $\Omega$ Ri 24/6	
<b>8852</b>	LOOP STEEL STAPLES	PUNTI METALLICI con $\Omega$ Ri 24/8	
<b>8853</b>	LOOP STEEL STAPLES	PUNTI METALLICI con $\Omega$ Ri 24/10	

**ZINC COATED STITCHING WIRE**
**FILO METALLICO ZINCATO**

Ref. Codice	Model Tipo	N°	Size Dimensioni	Roll Bobina	€
<b>8301</b>	FLAT WIRE	FILO PIATTO	<b>1</b> 0,75 x 0,35 mm	2 Kg	
<b>8304</b>	FLAT WIRE	FILO PIATTO	<b>2</b> 0,75 x 0,40 mm	2 Kg	
<b>8303</b>	FLAT WIRE	FILO PIATTO	<b>3</b> 0,75 x 0,55 mm	2 Kg	
<b>8309</b>	HARDENED FLAT WIRE	FILO ACCIAIOSO PIATTO	<b>3 C</b> 0,75 x 0,55 mm	2 Kg	
<b>8311</b>	FLAT WIRE	FILO PIATTO	<b>4</b> 0,85 x 0,55 mm	2 Kg	
<b>8302</b>	FLAT WIRE	FILO PIATTO	<b>5</b> 0,90 x 0,65 mm	2 Kg	
<b>8300</b>	HARDENED FLAT WIRE	FILO ACCIAIOSO PIATTO	<b>5 C</b> 0,90 x 0,65 mm	2 Kg	
<b>8305</b>	ROUND WIRE	FILO TONDO	<b>18</b> $\varnothing$ 1,20 mm	2 Kg	
<b>8312</b>	ROUND WIRE	FILO TONDO	<b>19</b> $\varnothing$ 1,10 mm	2 Kg	
<b>8313</b>	ROUND WIRE	FILO TONDO	<b>20</b> $\varnothing$ 1,00 mm	2 Kg	
<b>8306</b>	ROUND WIRE	FILO TONDO	<b>21</b> $\varnothing$ 0,90 mm	2 Kg	
<b>8307</b>	ROUND WIRE	FILO TONDO	<b>22</b> $\varnothing$ 0,80 mm	2 Kg	
<b>8308</b>	ROUND WIRE	FILO TONDO	<b>23</b> $\varnothing$ 0,70 mm	2 Kg	
<b>8310</b>	ROUND WIRE	FILO TONDO	<b>24</b> $\varnothing$ 0,60 mm	2 Kg	
<b>8314</b>	ROUND WIRE	FILO TONDO	<b>25</b> $\varnothing$ 0,55 mm	2 Kg	
<b>8318</b>	ROUND WIRE	FILO TONDO	<b>26</b> $\varnothing$ 0,50 mm	2 Kg	
<b>8319</b>	ROUND WIRE	FILO TONDO	<b>27</b> $\varnothing$ 0,45 mm	2 Kg	
<b>8322</b>	ROUND WIRE	FILO TONDO	<b>28</b> $\varnothing$ 0,40 mm	2 Kg	

## CUTTING / CREASING RULES



FILETTI

Ref. Codice	Color Colore		Pt	Height Altezza	Thickness Spessore	€	
<b>7031</b>	CREASING CENTRAL	CORDONATORE CENTRALE		2	22,8 mm	0,71 mm	
<b>7032</b>	CUTTING CENTRAL	TAGLIO CENTRALE		2	23,5 mm	0,71 mm	
<b>7046</b>	CUTTING CENTRAL	TAGLIO CENTRALE		2	23,8 mm	0,71 mm	
<b>7047</b>	CUTTING OFF CENTRE	TAGLIO LATERALE		2	23,8 mm	0,71 mm	
<b>7050</b>	PERFORATING 1x1	PERFORATORE 1x1	-----	2	23,5 mm	0,71 mm	
<b>7051</b>	PERFORATING 2x1	PERFORATORE 2x1	-----	2	23,5 mm	0,71 mm	
<b>7052</b>	PERFORATING 2x1	PERFORATORE 2x1	-----	2	22,8 mm	0,71 mm	

Ref. Codice	Model Descrizione	€
<b>7108</b>	BRASS COUNTER DRILLERS - ROLL 4 mm x 5,0 m	
	CONTROFORATORI IN OTTONE - BOBINA 4 mm x 5,0 m	
<b>7090</b>	BI-ADHESIVE FOR COUNTER DRILLER - 5 ROLL 4 mm x 25 m	
	BIADESIVO PER CONTROFORATORE - 5 BOBINE 4 mm x 25 m	
<b>7262</b>	SELF ADHESIVE STEEL 0,025 mm - ROLL 10 m	
	ACCIAIO AUTOADESIVO PER TACCHEGGIO 0,025 mm - BOBINA 10 m	
<b>7264</b>	SELF ADHESIVE STEEL 0,050 mm - ROLL 10 m	
	ACCIAIO AUTOADESIVO PER TACCHEGGIO 0,050 mm - BOBINA 10 m	

## OFFSET RULES

## NASTRI PERFORATORI OFFSET

Ref. Codice	Color Colore		Use with Adatto per	Cuts per inch Tagli x pollice	Box	€
<b>3102</b>	OFFSET-PERF-CENTER	— — — — —	PAPER / CARTA 60-200 g	3 teeth/"	6 m	
<b>3104</b>	OFFSET-PERF-CENTER	— — — — —	PAPER / CARTA 60-200 g	6 teeth/"	6 m	
<b>3106</b>	OFFSET-PERF-CENTER	— — — — —	PAPER / CARTA 60-200 g	8 teeth/"	6 m	
<b>3108</b>	OFFSET-PERF-CENTER	— — — — —	PAPER / CARTA 60-200 g	12 teeth/"	6 m	
<b>3110</b>	OFFSET-PERF-CENTER	— — — — —	PAPER / CARTA 60-200 g	16 teeth/"	6 m	
<b>3111</b>	OFFSET-PERF-SIDE	— — — — —	PAPER / CARTA 60-200 g	8 teeth/"	6 m	
<b>3112</b>	OFFSET-SCHNEID-CENTER	— — — — —	PAPER / CARTA 60-200 g	CUT/TAGLIO	6 m	
<b>3114</b>	OFFSET-RILL-CENTER		PAPER / CARTA 60-200 g	CREASING CORDONATURA	6 m	
<b>3116</b>	OFFSET-PERF-CENTER	— — — — —	CARDBOARD / CARTONE 200-300 g	3 teeth/"	6 m	
<b>3118</b>	OFFSET-PERF-CENTER	— — — — —	CARDBOARD / CARTONE 200-300 g	6 teeth/"	6 m	
<b>3120</b>	OFFSET-PERF-CENTER	— — — — —	CARDBOARD / CARTONE 200-300 g	8 teeth/"	6 m	
<b>3122</b>	OFFSET-PERF-CENTER	— — — — —	CARDBOARD / CARTONE 200-300 g	12 teeth/"	6 m	
<b>3124</b>	OFFSET-PERF-CENTER	— — — — —	CARDBOARD / CARTONE 200-300 g	16 teeth/"	6 m	
<b>3125</b>	OFFSET-PERF-SIDE	— — — — —	CARDBOARD / CARTONE 200-300 g	8 teeth/"	6 m	
<b>3126</b>	OFFSET-SCHNEID-CENTER	— — — — —	CARDBOARD / CARTONE 200-300 g	CUT/TAGLIO	6 m	
<b>3128</b>	OFFSET-RILL-CENTER		CARDBOARD / CARTONE 200-300 g	CREASING CORDONATURA	6 m	

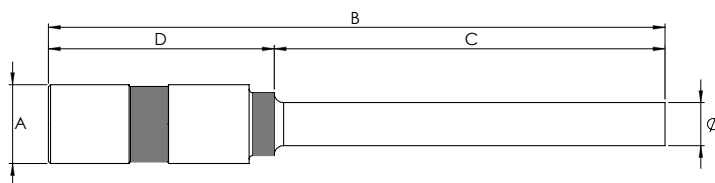

Ref. Codice	Ø mm	Ø Shaft (A) Ø Attacco (A)	Total lenght (mm) (B) Lunghezza totale (mm) (B)	Perforating lenght (mm) (C) Profondità foro (mm) (C)	Tang lenght (mm) (D) Lunghezza attacco (mm) (D)	€
<b>6047</b>	2,0	11	58	25	33	
<b>6048</b>	2,5	11	58	25	33	
<b>6049</b>	3,0	11	65	30	35	
<b>6050</b>	3,5	11	65	30	35	
<b>6051</b>	4,0	11	75	40	35	
<b>6052</b>	4,5	11	75	40	35	
<b>6053</b>	5,0	11	86	50	36	
<b>6054</b>	5,5	11	86	50	36	
<b>6055</b>	6,0	11	86	50	36	
<b>6056</b>	6,5	11	86	50	36	
<b>6057</b>	7,0	11	86	50	36	
<b>6058</b>	7,5	11	86	50	36	
<b>6059</b>	8,0	11	86	50	36	
<b>6060</b>	8,5	11	86	50	36	
<b>6061</b>	9,0	11	86	50	36	
<b>6062</b>	9,5	16	86	50	36	
<b>6063</b>	10,0	16	86	50	36	
<b>6064</b>	10,5	16	86	50	36	
<b>6065</b>	11,0	16	86	50	36	
<b>6066</b>	11,5	16	86	50	36	
<b>6067</b>	12,0	16	86	50	36	
<b>6068</b>	12,5	16	86	50	36	
<b>6069</b>	13,0	16	86	50	36	
<b>6070</b>	13,5	16	86	50	36	
<b>6071</b>	14,0	16	86	50	36	
<b>6085</b>	2,0	11	80	25	55	
<b>6086</b>	2,5	11	80	25	55	
<b>6087</b>	3,0	11	80	25	55	
<b>6088</b>	3,5	11	80	25	55	
<b>6078</b>	5,0	11	100	70	30	
<b>6079</b>	5,5	11	100	70	30	
<b>6080</b>	6,0	11	100	70	30	
<b>6081</b>	6,5	11	100	70	30	
<b>6082</b>	7,0	11	100	70	30	
<b>6083</b>	7,5	11	100	70	30	
<b>6084</b>	8,0	11	100	70	30	

## TEFLON COATED PAPER DRILL BITS

## PUNTE PER TRAPANI TEFLONATE

Ref. Codice	Ø mm	Ø Shaft (A) Ø Attacco (A)	Total lenght (mm) (B) Lunghezza totale (mm) (B)	Perforating lenght (mm) (C) Profondità foro (mm) (C)	Tang lenght (mm) (D) Lunghezza attacco (mm) (D)	€
<b>6149</b>	3,0	11	75	40	35	
<b>6151</b>	4,0	11	75	40	35	
<b>6153</b>	5,0	11	86	50	36	
<b>6155</b>	6,0	11	86	50	36	
<b>6157</b>	7,0	11	86	50	36	
<b>6159</b>	8,0	11	86	50	36	

## PAPER DRILL BITS

## PUNTE PER TRAPANI

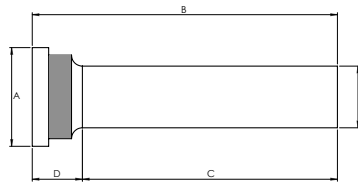

Ref. Codice	Ø mm	Ø Shaft (A) Ø Attacco (A)	Total lenght (mm) (B) Lunghezza totale (mm) (B)	Perforating lenght (mm) (C) Profondità foro (mm) (C)	Tang lenght (mm) (D) Lunghezza attacco (mm) (D)	€
<b>6072</b>	15,0	24	74	60	14	
<b>6073</b>	16,0	24	74	60	14	
<b>6074</b>	17,0	24	74	60	14	
<b>6075</b>	18,0	24	74	60	14	
<b>6076</b>	19,0	24	74	60	14	
<b>6077</b>	20,0	24	74	60	14	

## PAPER DRILL ACCESSORIES

## ACCESSORI PER TRAPANI

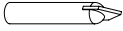
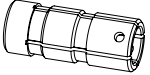
<b>6089</b>	WAX PAPER	BLOCCO CARTA PARAFFINATA	7,5 x 20 cm - h: 2,5 cm	
<b>6090</b>	PARAFFINE BLOCK	BLOCCO PARAFFINA	8 x 11 cm - H: 3,0 cm	
<b>6095</b>	SHARPENING STONE	PIETRA ABRASIVA PER FUSTELLE	25 x 100 x 5 mm	
<b>6091</b>	SHARPENER FOR DRILLING MACHINE - ALL DIAMETERS AFFILATORE PER FUSTELLE - TUTTI I DIAMETRI			
<b>6092</b>	WIDIA SPARE PART FOR SHARPENER RICAMBIO WIDIA PER AFFILATORE PER FUSTELLE			
<b>9756</b>	COLLET FOR MERCURY COLLET CHUCK PINZA MANDRINO MERCURY			

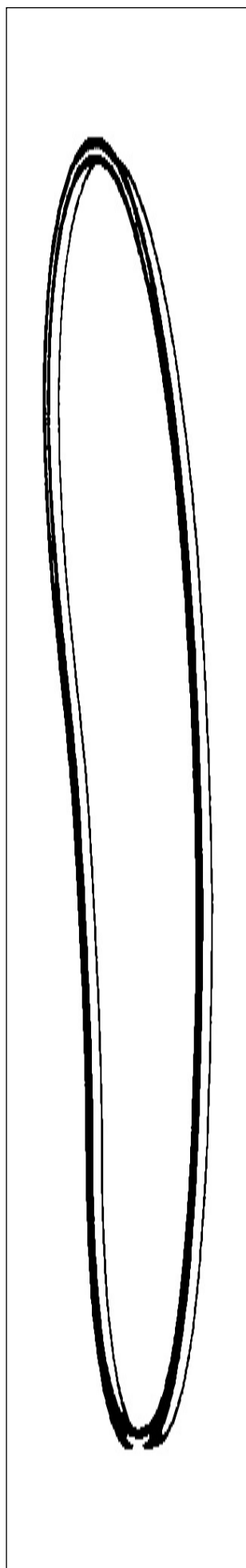

Ref. Codice	Belt N. Cod. Cinghia	Model Descrizione	L (mm)	€
<b>9005</b>	47J2320	HEIDELBERG PLATEN T 26x38 - old model - up to serial n. 160.000 HEIDELBERG STELLA T 26x38 - mod. vecchio - fino matr. 160.000	2.320	
<b>9010</b>	47J2290	HEIDELBERG PLATEN T 26x38 - new model - over serial n. 160.000 HEIDELBERG STELLA T 26x38 - mod. nuovo - oltre matr. 160.000	2.290	
<b>9015</b>	47J2880	HEIDELBERG PLATEN GT 32x46 HEIDELBERG STELLA GT 32x46	2.880	
<b>9020</b>	47J1820	HEIDELBERG KS / KSB / KSBA HEIDELBERG KS / KSB / KSBA	1.820	
<b>9022</b>	47J1880	HEIDELBERG KOR / KORA / KORD / KORS HEIDELBERG KOR / KORA / KORD / KORS	1.880	
<b>9025</b>	47J1580	HEIDELBERG SORM HEIDELBERG SORM	1.580	
<b>9030</b>	1168J10	FLYWHEEL HEIDELBERG GTO 46 MONOCOLOR VOLANO HEIDELBERG GTO 46 MONOCOLORE	1.168	
<b>9031</b>	1397J24	FLYWHEEL HEIDELBERG GTO 46/52 - 2 & 4 COLORS VOLANO HEIDELBERG GTO 46/52 - 2 e 4 COLORI	1.397	
<b>9032</b>	1321J16	FLYWHEEL HEIDELBERG GTO 52 MONOCOLOR VOLANO HEIDELBERG GTO 52 MONOCOLORE	1.321	
<b>9035</b>	28H0950	VARIOMATIC HEIDELBERG GTO 46/52 VARIATORE HEIDELBERG GTO 46/52	955	
<b>9036</b>	1550J24	SHEET FEEDER HEIDELBERG GTO ZS METTIFOGLIO HEIDELBERG GTO ZS	1.550	
<b>9037</b>	37J1060	VARIOMATIC HEIDELBERG GTO 46/52 BICOLOR VARIATORE HEIDELBERG GTO 46/52 BICOLORE	1.060	
<b>9033</b>	-	HEIDELBERG GTO 46/52 - ANTI SET-OFF POWDER HEIDELBERG GTO 46/52 - ANTISCARTINO	460	
<b>9038</b>	2134L19	HEIDELBERG SPEEDMASTER HEIDELBERG SPEEDMASTER	2.134	
<b>9039</b>	1473J580	HEIDELBERG MO HEIDELBERG MO	1.473	

## FEEDER BELTS

## CINGHIE PER METTIFOGLIO

Ref. Codice	Model Descrizione	Length Lunghezza	Width Larghezza	Holes Fori	€
<b>9052</b>	HEIDELBERG GTO	1.220 mm	89 mm	●	
<b>9053</b>	HEIDELBERG SPEEDMASTER 52	950 mm	60 mm	●	
<b>9054</b>	HEIDELBERG MO	1.350 mm	25 mm		
<b>9055</b>	HEIDELBERG SORK / SORD / SORM	1.440 mm	28 mm		
<b>9056</b>	HEIDELBERG SORK-Z / SORD-Z / SORM-Z	2.015mm	28 mm		
<b>9057</b>	HEIDELBERG SPEEDMASTER 72 / 102	2.015 mm	27 mm		
<b>9058</b>	HEIDELBERG SPEEDMASTER 102 slow down ring / anello di rallentamento	220 mm	38 mm	●	
<b>9061</b>	HEIDELBERG SPEEDMASTER 74	1.235 mm	54 mm	●	
<b>9062</b>	HEIDELBERG SPEEDMASTER 74	1.235 mm	54 mm		
<b>9064</b>	HEIDELBERG SPEEDMASTER 74 slow down ring / anello di rallentamento	230 mm	20 mm	●	
<b>9066</b>	HEIDELBERG SPEEDMASTER 74 slow down ring / anello di rallentamento	220 mm	20 mm	●	
<b>9071</b>	ROLAND FAVORIT - OB	1.356 mm	28 mm		
<b>9063</b>	ROLAND 200	1.440 mm	50 mm	●	
<b>9070</b>	ROLAND 300	1.040 mm	50 mm	●	
<b>9072</b>	ROLAND ROLAND 600 / REKORD 3B	1.977 mm	28 mm		
<b>9073</b>	ROLAND 700	2.886 mm	80 mm	●	
<b>9075</b>	ROLAND 800	2.050 mm	28 mm		
<b>9076</b>	KOMORI LITHRONE 26	1.680 mm	25 mm		
<b>9077</b>	KOMORI SPRINT 26	1.325 mm	28 mm		
<b>9078</b>	KOMORI LITHRONE 28 / 428 / 528 / 628	2.000 mm	25 mm		
<b>9079</b>	KOMORI LITHRONE 40	2.300 mm	25 mm		
<b>9084</b>	MITSUBISHI 3F / 3E	1.980 mm	24 mm		
<b>9085</b>	KBA RAPIDA 104 / 105	2.600 mm	28 mm		
<b>9087</b>	KBA RAPIDA 142 / 162	3.160 mm	40 mm		
<b>9091</b>	KBA RAPIDA 142 / 162	3.160 mm	80 mm	●	

## SMALL PUNCHES

## FUSTELLINE

	Ref. Codice	Model Descrizione	Body Corpo	€
	<b>7003</b>	Ø 3 mm	20	
	<b>7004</b>	Ø 4 mm	20	
	<b>7005</b>	Ø 5 mm	20	
	<b>7006</b>	Ø 6 mm	20	
	<b>7007</b>	Ø 7 mm	20	
	<b>7008</b>	Ø 8 mm	30	
	<b>7009</b>	Ø 9 mm	30	
<b>7010</b>	Ø 10 mm	30		

## METALLIC EYELETS

## OCCHIELLI IN METALLO

Ref. Codice	Model Tipo	Measure Misura	€
<b>8078</b>	SMALL METALLIC EYELETS - BOX 10.000 PIECES - PRICE EACH BOX OCCHIELLI METALLICI PICCOLI - CONF. DA 10.000 PZ - PREZZO PER CONFEZIONE	H: 4 mm - Ø int. 4 mm 1054 R	
<b>8080</b>	BIG METALLIC EYELETS - BOX 2.500 PIECES - PRICE EACH BOX OCCHIELLI METALLICI GRANDI - CONF. DA 2.500 PZ - PREZZO PER CONFEZIONE	H: 6 mm - Ø int. 6 mm 1450 S	

## THERMOGRAPHIC POWDER

## POLVERE PER RILIEVO

Ref. Codice	Color Colore	NR	Type Tipo	Weight Peso	€
<b>6036</b>	TRANSPARENT TRASPARENTE	611	MEDIUM / MEDIA	1 Kg	
<b>6038</b>	TRANSPARENT TRASPARENTE	614	THIN / FINE	1 Kg	
<b>6040</b>	TRANSPARENT TRASPARENTE	618	EXTRA THIN / EXTRA FINE	1 Kg	
<b>6042</b>	PORCELAIN WHITE BIANCO NEVE	614	THIN / FINE	1 Kg	
<b>6043</b>	PORCELAIN WHITE BIANCO NEVE	618	EXTRA THIN / EXTRA FINE	1 Kg	
<b>6044</b>	SILVER ARGENTO	614	THIN / FINE	1 Kg	
<b>6046</b>	GOLD ORO	614	THIN / FINE	1 Kg	

## GLUE

## COLLA

Ref. Codice	Type Tipo	Use Uso	Weight Peso	€
<b>8700</b>	PLANATOL FF	FOR BLOCKS / PER BLOCCHI	1 Kg	
<b>8701</b>	PLANATOL FF	FOR BLOCKS / PER BLOCCHI	5,5 Kg	
<b>8716</b>	PLANATOL BB SUPERIOR	FOR ART PAPER / PER CARTA PATINATA	1 Kg	
<b>8717</b>	PLANATOL BB SUPERIOR	FOR ART PAPER / PER CARTA PATINATA	5,5 Kg	
<b>8733</b>	FGG 98/C	FOR MASTICHING / PER MASTICIARE	2 Kg	
<b>8734</b>	FGG 98/EA	FOR PLASTIC / PER PLASTICA	2 Kg	
<b>8735</b>	FGG 86/AF SELF SEPARATING - AUTOSEPARANTE	FOR CHEMICAL PAPER / PER CARTA CHIMICA	1 Kg	





## PRE-PRESS

## PRESTAMPA

Ref. Codice	Description Descrizione	Measure Misura	€
<b>3400</b>	BIG CUTTER CUTTER GRANDE	-	
<b>3402</b>	BIG KAI BLADES / LAMETTE GRANDI KAI	BOX 10 PCS - CONF 10 PZ.	
<b>3404</b>	SMALL CUTTER CUTTER PICCOLO	-	
<b>3406</b>	SMALL KAI BLADES / LAMETTE PICCOLE KAI	BOX 10 PCS - CONF 10 PZ.	
<b>3410</b>	SCISSORS / FORBICI	14 cm	
<b>3416</b>	SCISSORS / FORBICI	25 cm	
<b>3350</b>	NIBS FOR FILM - BOX 20 PCS SGARZINI PER PELLICOLA - CONF 20 PZ.		
<b>3352</b>	SMALL STAWS FOR NIBS CANNUCCIA PER SGARZINI	-	
<b>6223</b>	TYPOGRAPHIC TWEEZERS PINZETTA TIPOGRAFICA CON PUNTA	-	
<b>4130</b>	POLYSTYRENE TAB TAMPONE IN POLISTIROLO	-	
<b>4134</b>	PLASTIC and RUBBER DOCTOR BLADE RACLA IN PLASTICA e GOMMA	L: 40 cm	

## MAGNIFIER

## LENTINI

Ref. Codice	Description Descrizione	Measure Misura	€
<b>3502</b>	SMALL MAGNIFIER / LENTINO 20x20 - 8x		
<b>3504</b>	SMALL MAGNIFIER / LENTINO 25x25 - 6x		
<b>3506</b>	SMALL MAGNIFIER / LENTINO 30x30 - 6x		
<b>3424</b>	MAGNIFIER Ø50 mm WITH HANDLE LENTE Ø50 mm CON MANICO		
<b>3428</b>	MAGNIFIER Ø70 mm WITH HANDLE LENTE Ø70 mm CON MANICO		

## MEASURING INSTRUMENTS

## STRUMENTI DI MISURA

Ref. Codice	Description Descrizione	Measure Misura	€
<b>6214</b>	STEEL TYPOMETER TIPOMETRO IN ACCIAIO	36 cm	
<b>6216</b>	STEEL TYPOMETER TIPOMETRO IN ACCIAIO	50 cm	
<b>6408</b>	MICROMETER MICROMETRO		
<b>6409</b>	DECIMAL STOP BAR CASE SPESSIMETRO DECIMALE		
<b>6410</b>	SMALL SCALE FOR PAPER BILANCINA PESA CARTA		

## WASHING

## LAVAGGIO

Ref. Codice	Description Descrizione	Measure Misura	€
<b>4152</b>	PRESSED SPONGES SPUGNE PRESSATE	14 x 10 cm	
<b>4154</b>	CELLULOSE SPONGES SPUGNE IN CELLULOSA	14 x 10 cm	
<b>4158</b>	MEDIUM SIZE MARINE SPONGES SPUGNE MARINE MEDIE	-	
<b>3040</b>	TEX CLOTH ROLL BOBINA PANNINO TEX	5 Kg	
<b>6415</b>	PLASTIC BOTTLE WITH STRAW BOCCETTA PLASTICA CON CANNUCCIA	0,5 l	
<b>6414</b>	PLASTIC BOTTLE WITH STRAW BOCCETTA PLASTICA CON CANNUCCIA	1 l	
<b>3604</b>	ANTI-ACID GLOVES GUANTI ANTIACIDO	8	
<b>3606</b>	ANTI-ACID GLOVES GUANTI ANTIACIDO	9	
<b>3608</b>	ANTI-ACID GLOVES GUANTI ANTIACIDO	10	
<b>3610</b>	LATEX GLOVES GUANTI IN LATTICE	SMALL (box 100 pcs)	
<b>3611</b>	LATEX GLOVES GUANTI IN LATTICE	MEDIUM (box 100 pcs)	
<b>3612</b>	LATEX GLOVES GUANTI IN LATTICE	LARGE (box 100 pcs)	

## BI-ADHESIVE

## BIADESIVO

Ref. Codice	Type Tipo	Color Colore	Size Misura	€
<b>6591</b>	BI-ADHESIVE / BIADESIVO 0,10 - PVC	YELLOW / GIALLO	310 mm x 4,5 m	
<b>6592</b>	BI-ADHESIVE / BIADESIVO 0,20 - PVC	BROWN / MARRONE	310 mm x 4,5 m	
<b>6593</b>	BI-ADHESIVE / BIADESIVO 0,30 - PVC	GREEN / VERDE	310 mm x 4,5 m	
<b>2310</b>	TESA 010 - PVC	WHITE / BIANCO	310 mm x 10 m	
<b>2320</b>	TESA 020 - PVC	WHITE / BIANCO	310 mm x 10 m	
<b>2330</b>	TESA 030 - TELATO	WHITE / BIANCO	310 mm x 4,5 m	
<b>6594</b>	BI-ADHESIVE "TRANSFER"	BOX 12	12 mm x 33 m	
<b>6595</b>	BI-ADHESIVE "TRANSFER"	BOX 8	19 mm x 33 m	
<b>6596</b>	DISPENSER FOR BI-ADHESIVE "TRANSFER" ATS-50 DISPENSER PER BIADESIVO "TRANSFER" ATS-50			

## PACKAGING

## IMBALLO

Ref. Codice	Description Descrizione	Measure Misura	€
<b>6640</b>	CARTON SEALING TAPE ROTOLO PVC AVANA PER IMBALLO	50 m x 66 mm	
<b>6641</b>	HAND DISPENSER DISPENSER NASTRO ADESIVO	-	
<b>6597</b>	STRETCH-FILM FILM ESTENSIBILE 500 mm x 23 my - int. Ø 50 mm - 2,7 Kg	BOX 6 ROLLS	
<b>6598</b>	DISPENSER FOR STRETCH-FILM DISPENSER FILM ESTENSIBILE	-	

## INK KNIVES

## SPATOLE PER INCHIOSTRO

Ref. Codice	Description Descrizione	Measure Misura	€
<b>6230</b>	METAL INK KNIVE SPATOLA IN ACCIAIO	3 cm	
<b>6231</b>	METAL INK KNIVE SPATOLA IN ACCIAIO	4 cm	
<b>6232</b>	METAL INK KNIVE SPATOLA IN ACCIAIO	5 cm	
<b>6233</b>	METAL INK KNIVE SPATOLA IN ACCIAIO	6 cm	
<b>6234</b>	METAL INK KNIVE SPATOLA IN ACCIAIO	7 cm	
<b>6235</b>	METAL INK KNIVE SPATOLA IN ACCIAIO	8 cm	
<b>6236</b>	METAL INK KNIVE SPATOLA IN ACCIAIO	9 cm	
<b>6237</b>	METAL INK KNIVE SPATOLA IN ACCIAIO	10 cm	
<b>6240</b>	PLASTIC INK KNIVES - KIT 4 KNIVES BLACK+RED+YELLOW+CYAN SPATOLE IN PLASTICA - KIT 4 SPATOLE NERA+ROSSA+GIALLA+CIANO	4,5 cm	
<b>6241</b>	PLASTIC INK KNIVES - KIT 4 KNIVES BLACK+RED+YELLOW+CYAN SPATOLE IN PLASTICA - KIT 4 SPATOLE NERA+ROSSA+GIALLA+CIANO	7 cm	

## PLASTIC FEEDER WEDGES

## CUNEI IN PLASTICA

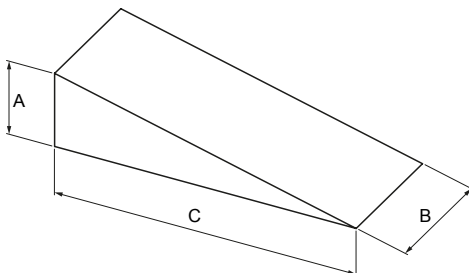

Ref. Codice	Description Descrizione	Measure (A x B x C) Misura (A x B x C)	€
<b>9496</b>	FEEDER WEDGE "A" CUNEO "A"	30 x 35 x 105 mm	
<b>9497</b>	FEEDER WEDGE "B" CUNEO "B"	30 x 35 x 195 mm	
<b>9498</b>	FEEDER WEDGE "C" CUNEO "C"	30 x 60 x 195 mm	
<b>9499</b>	FEEDER WEDGE "D" CUNEO "D"	25 x 75 x 195 mm	
<b>9143</b>	FEEDER WEDGE "E" CUNEO "E"	11 x 20 x 100 mm	

## OTHER

## ARTICOLI VARI

Ref. Codice	Description Descrizione	Measure Misura	€
<b>6424</b>	SILICONE-BASED SLIDING SPRAY SCIVOLANTE SPRAY AL SILICONE	400 ml	
<b>8087</b>	BONE FOLDER PIGHETTA OSSO	L: 16 cm	