

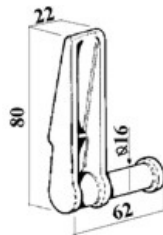

art. 15105  
SPINOTTO D.9  
gr. 60

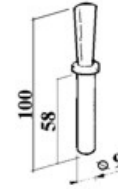

art. 15101  
CERNIERA POST. LEGGERA  
gr. 200

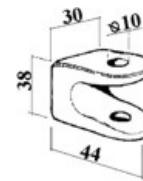

art. 15103  
SUPPORTO LEGGERO  
gr. 150



art. 15104  
SPINOTTO D.12  
gr. 110

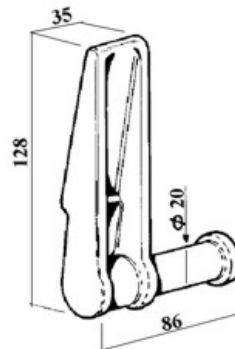
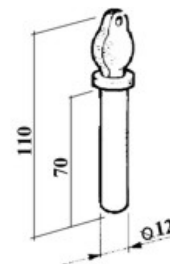

art. 15112  
CERNIERA POST. PESANTE  
gr. 550

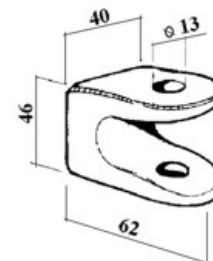

art. 15116  
SUPPORTO PESANTE  
gr. 380



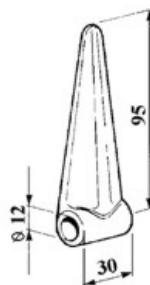

art. 15118  
CERNIERA BOMBATA LEGGERA  
gr. 140

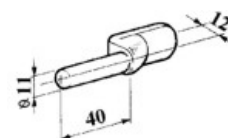

art. 20100  
PERNO D. 11  
gr. 80

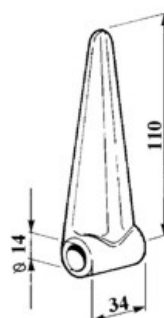

art. 15120  
CERNIERA BOMBATA MEDIA  
gr. 170

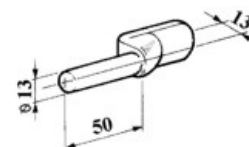

art. 20102  
PERNO D. 13  
gr. 110

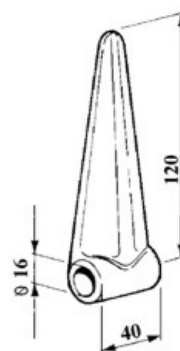

art. 15122  
CERNIERA BOMBATA PESANTE  
gr. 250

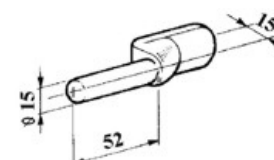

art. 20104  
PERNO D. 15  
gr. 160

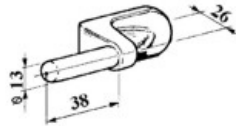
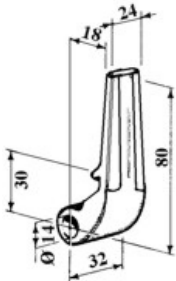

art. 15148  
CERNIERA CORTA  
IN FUORI  
gr. 180

art. 20122  
PERNO D. 13  
gr. 140

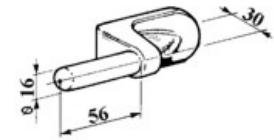
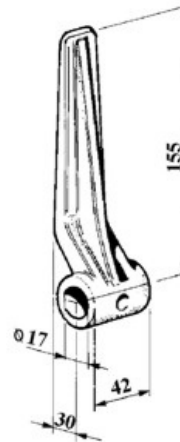

art. 15164  
CERNIERA LAZIO  
gr. 640

art. 20114  
PERNO D. 16  
gr. 230

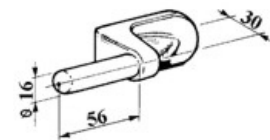
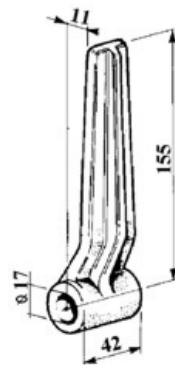

art. 15166  
CERNIERA NERVATURA  
IN FUORI  
gr. 350

art. 20114  
PERNO D. 16  
gr. 230

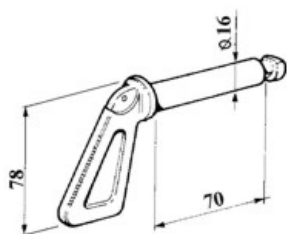

art. 15184  
MANIGLIA STOPPED  
gr. 220

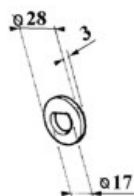

art. 15182  
DISPOSITIVO STOPPED  
gr. 20

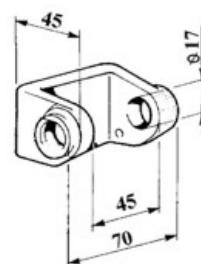

art. 15178  
SUPPORTINO  
gr. 260

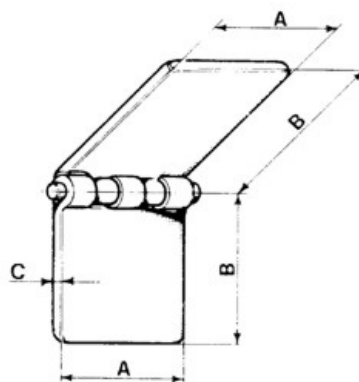

**CERNIERA A LIBRO**

Art.	A	B	C	Peso gr.
15201	50	60	6	320
15202	60	90	7	480

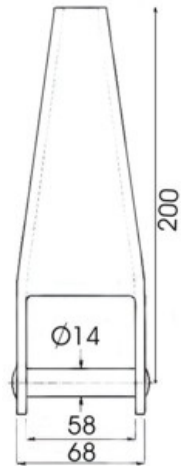

art. 15204  
CERNIERA T/PARIPIANALE ALTA  
gr. 690

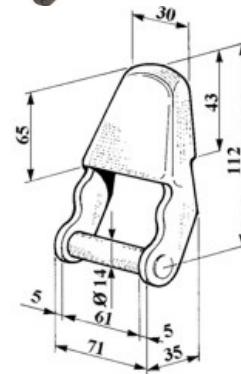

art. 15206  
CERNIERA T/PARIPIANALE  
gr. 340

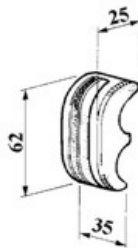

art. 15214  
PALETTA  
gr. 140

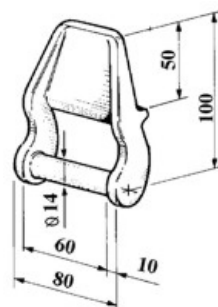

art. 15208  
CERNIERA LEGGERA  
gr. 500

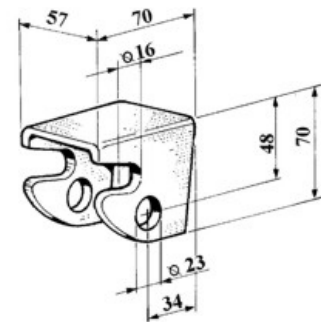

art. 15212  
SUPPORTO  
gr. 430

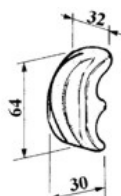

art. 15223  
PALETTA  
gr. 200

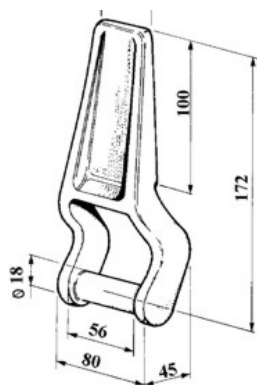

art. 15216  
CERNIERA PESANTE ALTA  
gr. 920

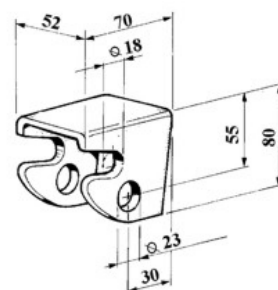

art. 15220  
SUPPORTO GUIDA ASTA  
gr. 500

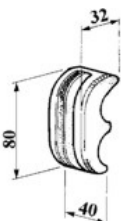

art. 15242  
PALETTA  
gr. 240

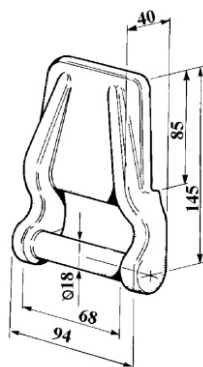

art. 15236  
CERNIERA PESANTE  
gr. 1.250

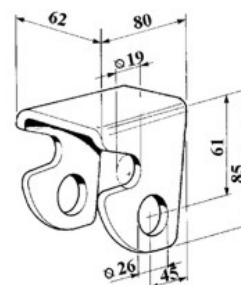

art. 15240  
SUPPORTO GUIDA ASTA  
gr. 600



art. 15270  
PIASTRINA  
gr. 40

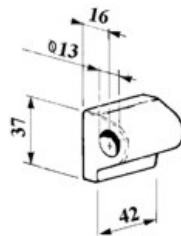
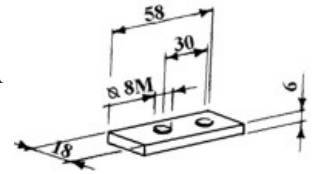

art. 15274  
CERNIERA LEGGERA  
gr. 180

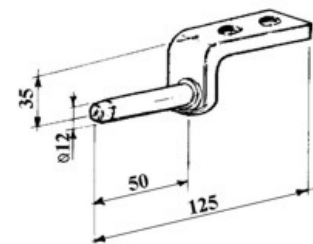

art. 15276  
PERNO LEGGERO  
gr. 200

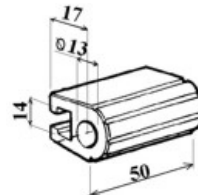

art. 15275  
CERNIERA ALLUMINIO  
gr. 70

art. 15338  
VITE BRUGOLA ZINC.8x20  
gr. 13



art. 15278  
PIASTRINA  
gr. 80

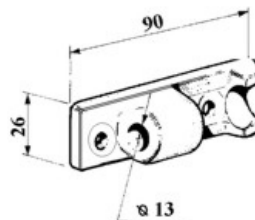
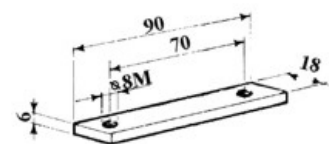

art. 15282  
CERNIERA TIR LEGGERA  
gr. 190

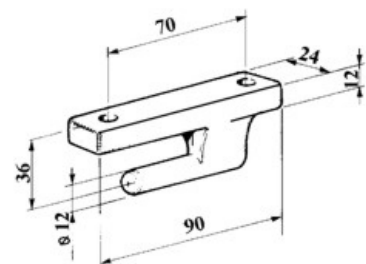

art. 15280  
PERNO TIR LEGGERO  
gr. 230

art. 15338  
VITE BRUGOLA ZINC.8x20  
gr. 13





art. 15285  
PIASTRINA  
gr. 95

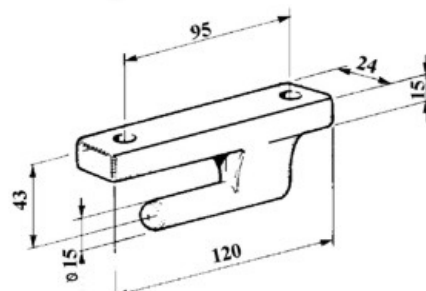
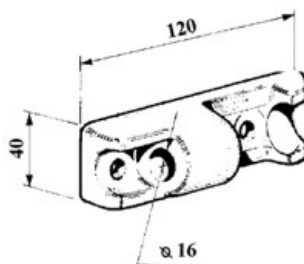
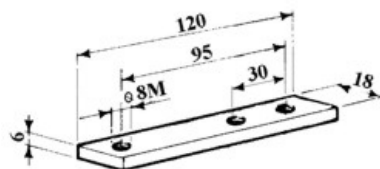

art. 15290  
PERNO TIR PESANTE  
gr. 400



art. 15292  
CERNIERA TIR PESANTE  
gr. 400



art. 15338  
VITE BRUGOLA ZINC.8x20  
gr. 13

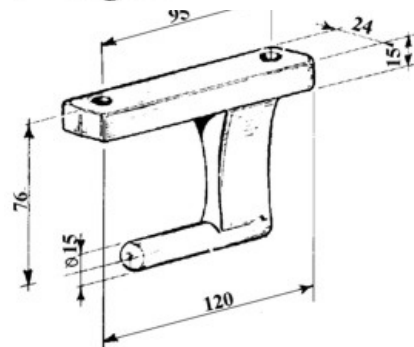
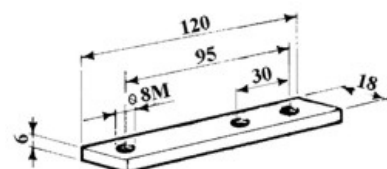
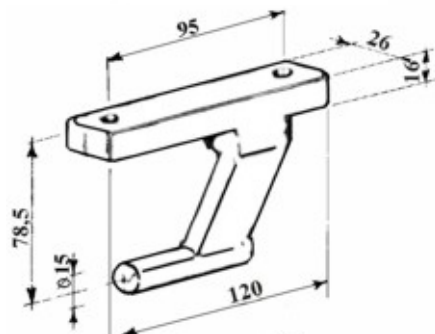
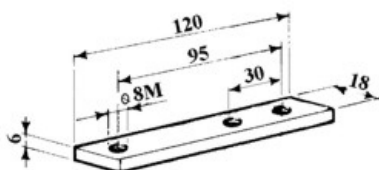

art. 15288  
PERNO TIR PES. ALTO  
INCLINATO  
gr. 450



art. 15289  
PERNO TIR PES. ALTO  
gr. 450







art. 15285  
PIASTRINA  
gr. 95

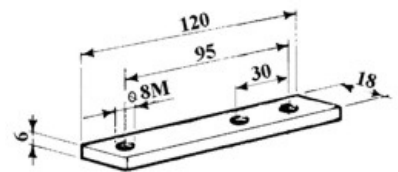

art. 15298  
CERNIERA RAPID  
gr. 280

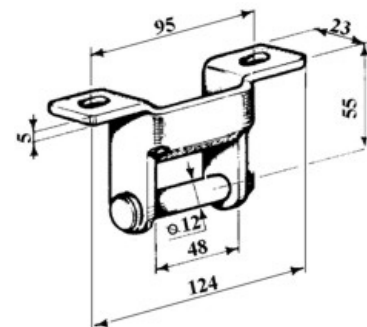

art. 15338  
VITE BRUGOLA ZINC.8x20  
gr. 13



art. 15300  
SUPPORTO  
gr. 180

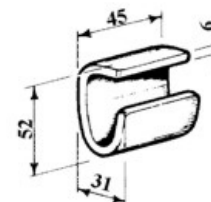

art. 15306  
PIASTRINA  
gr. 100

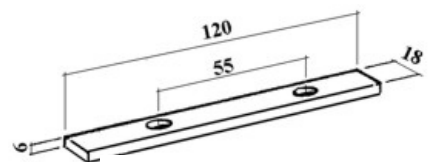

art. 15308  
CERNIERA VIBERTI  
gr. 290

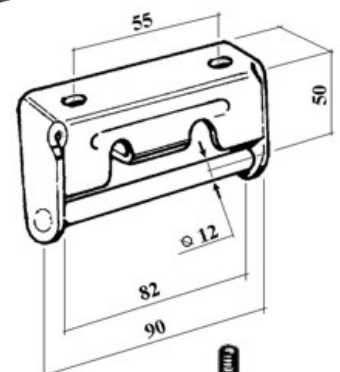

art. 15338  
VITE BRUGOLA ZINC.8x20  
gr. 13



art. 15310  
SUPPORTO CERNIERA  
gr. 200

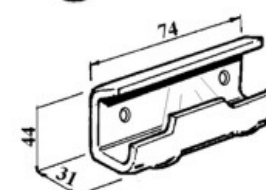

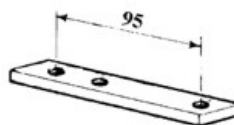

art. 15285  
PIASTRINA  
gr. 95



art. 15344  
CERNIERA ALL.25  
gr. 380

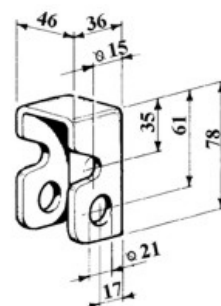
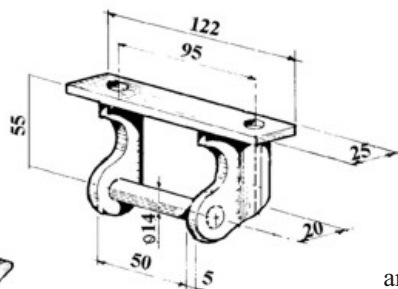

art. 15350  
SUPPORTO GUIDA ASTA  
gr. 250



art. 15214  
PALETTA  
gr. 140

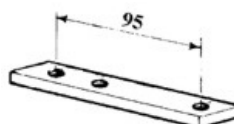

art. 15285  
PIASTRINA  
gr. 95



art. 15348  
CERNIERA ALL.30  
gr. 450

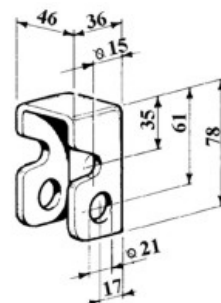
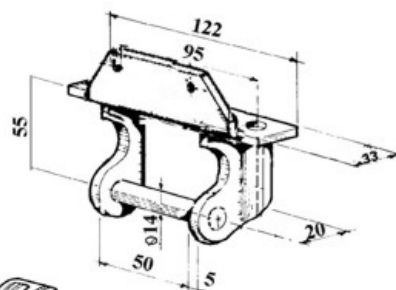

art. 15350  
SUPPORTO GUIDA ASTA  
gr. 250



art. 15214  
PALETTA  
gr. 140



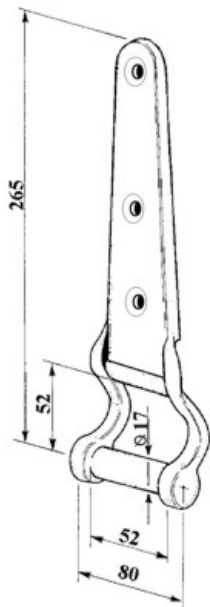

art. 15360  
CERNIERA S/FORI GREZZA H265  
gr. 770

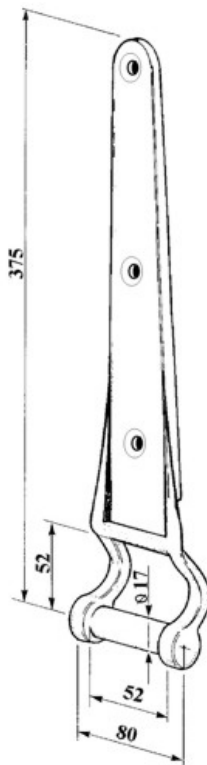

art. 15342  
VITE SVASATA ZINC.8x25  
gr. 43

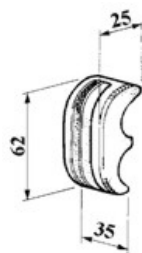

art. 15214  
PALETTA

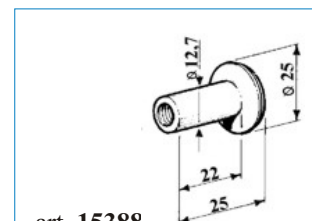

art. 15388  
BUSSOLOTTO ALL.25  
gr. 10

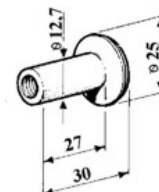

art. 15390  
BUSSOLOTTO ALL.30  
gr. 15

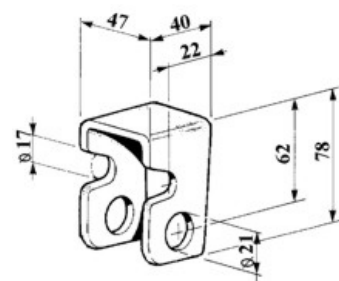

art. 15364  
SUPPORTO ALTO  
gr. 240

art. 15361  
CERNIERA ALTA H375  
gr. 1.050

art. 15362  
CERNIERA ALTA H265  
gr. 770

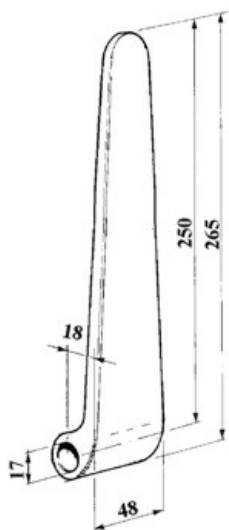

art. 20108  
PERNO  
gr. 180

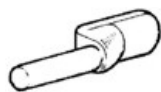

art. 15174  
ORECCHIETTA

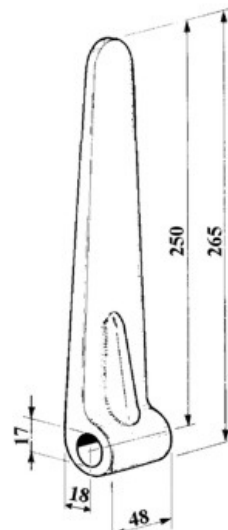

art. 15184  
MANIGLIA



art. 15368  
CERNIERA LAT. H265  
gr. 740

art. 15369  
CERNIERA POST. H265  
gr. 790

art. 15372  
CERNIERA LAT. H375  
gr. 850

art. 15373  
CERNIERA POST. H375  
gr. 900



art. 15380  
PALETTA LEGGERA  
gr. 33

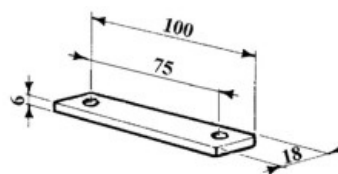

art. 15382  
PIASTRINA  
gr. 80

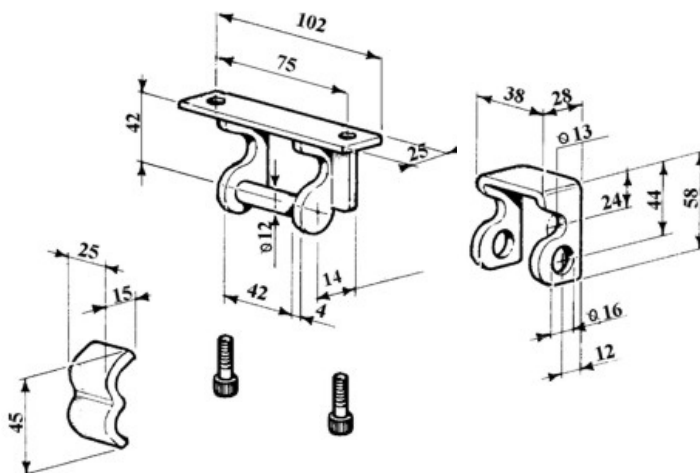

art. 15376  
CERNIERA LEGGERA  
gr. 210

art. 15378  
SUPPORTO LEGGERO  
gr. 90

art. 15410  
CERNIERA LEGGERA  
gr. 380

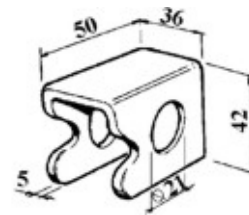
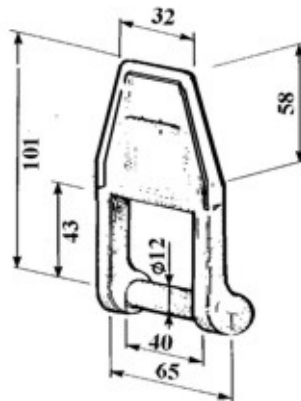

art. 15416  
PALETTA  
gr. 80

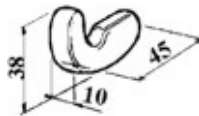

art. 15414  
SUPPORTO GUIDA ASTA  
gr. 150

art. 41527  
PROFILO TR1 CON CERNIERA



art. 15416  
PALETTA  
gr. 80



art. 15414  
SUPPORTO GUIDA ASTA  
gr. 150

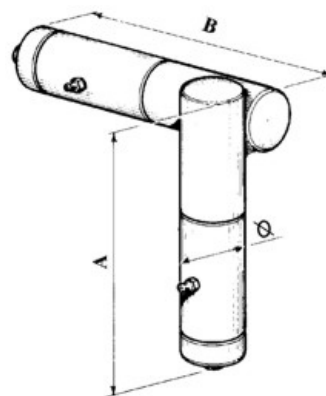

**CERNIERA APERTURA  
LIBRO SUPERIORE**

articolo	Ø	A	B	Peso gr.
15534	35	135	135	2.000
15543	40	175	175	2.600
15538	50	215	215	6.700
15546	60	215	215	9.500

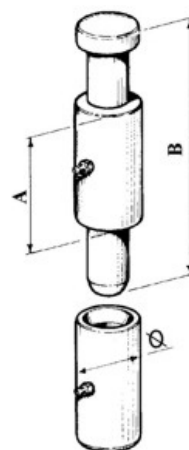
**CERNIERA APERTURA  
LIBRO INFERIORE**

articolo	Ø	A	B	Peso gr.
15536	35	80	140	970
15545	40	80	180	1.200
15540	50	100	230	3.400
15548	60	100	230	5.000